

20 -17



SPRING
2017

MUUTO
New Nordic

NEW PERSPECTIVES ON SCANDINAVIAN DESIGN

Muuto is rooted in the Scandinavian design tradition characterised by enduring aesthetics, functionality, craftsmanship and an honest expression.

By expanding this heritage with forward looking materials, techniques and bold creative thinking, our ambition is to deliver a new perspective on Scandinavian design. In fact our name **MUUTO** comes from *muutos*, meaning new perspective in Finnish.

We handpick leading contemporary designers who are strong interpreters of our philosophy and then combine their talent with the passionate Muuto creative team.

You will know our design because it has muutos. Objects made sublime through new perspectives, enjoyed across the world, representing the best of Scandinavian design today.



OUTLINE SOFA & CHAIR
by Andersen & Voll p. 40

PLY RUG
by Margrethe Odgaard p. 55

RIPPLE THROW
By Margrethe Odgaard p. 55

LEAF LAMP
by Broberg & Ridderstråle p. 51

An honest chair with few but right details. Its refined joints and the visible wooden grains in the chair's structure, emphasize the craftsmanship put into creating the **WORKSHOP** chair

WORKSHOP CHAIR
by Cecilie Manz p. 45

BASE TABLE
by Mika Tolvanen p. 48

AMBIT LAMP
by TAF Architects p. 49

CORKY SERIES
by Andreas Engesvik p. 53



WORKSHOP CHAIR

5

6



DOTS METAL

THE DOTS METAL HOOKS
by Lars Tornøe p. 45

CONTROL LAMP
by TAF Architects p. 53



STACKED STORAGE SYSTEM
by Julien De Smedt p. 42

PLY RUG
by Margrethe Odgaard p. 55

OUTLINE CHAIR
by Anderssen & Voll p. 40

AIRY COFFEE TABLE
by Cecilie Manz p. 41

The **SPLIT** table has an organic expression and combines a structural solidity with a seemingly more delicate balancing act



FIBER SIDE CHAIR
by Iskos-Berlin p. 44

SPLIT TABLE
by Staffan Holm p. 48

AMBIT LAMP
by TAF Architects p. 49



The TILE cushion's complex weaving technique creates a pattern, appearing monochrome from a distance yet rich on details up close, setting it aside from a merely dyed pattern

COMPOSE SOFA

10

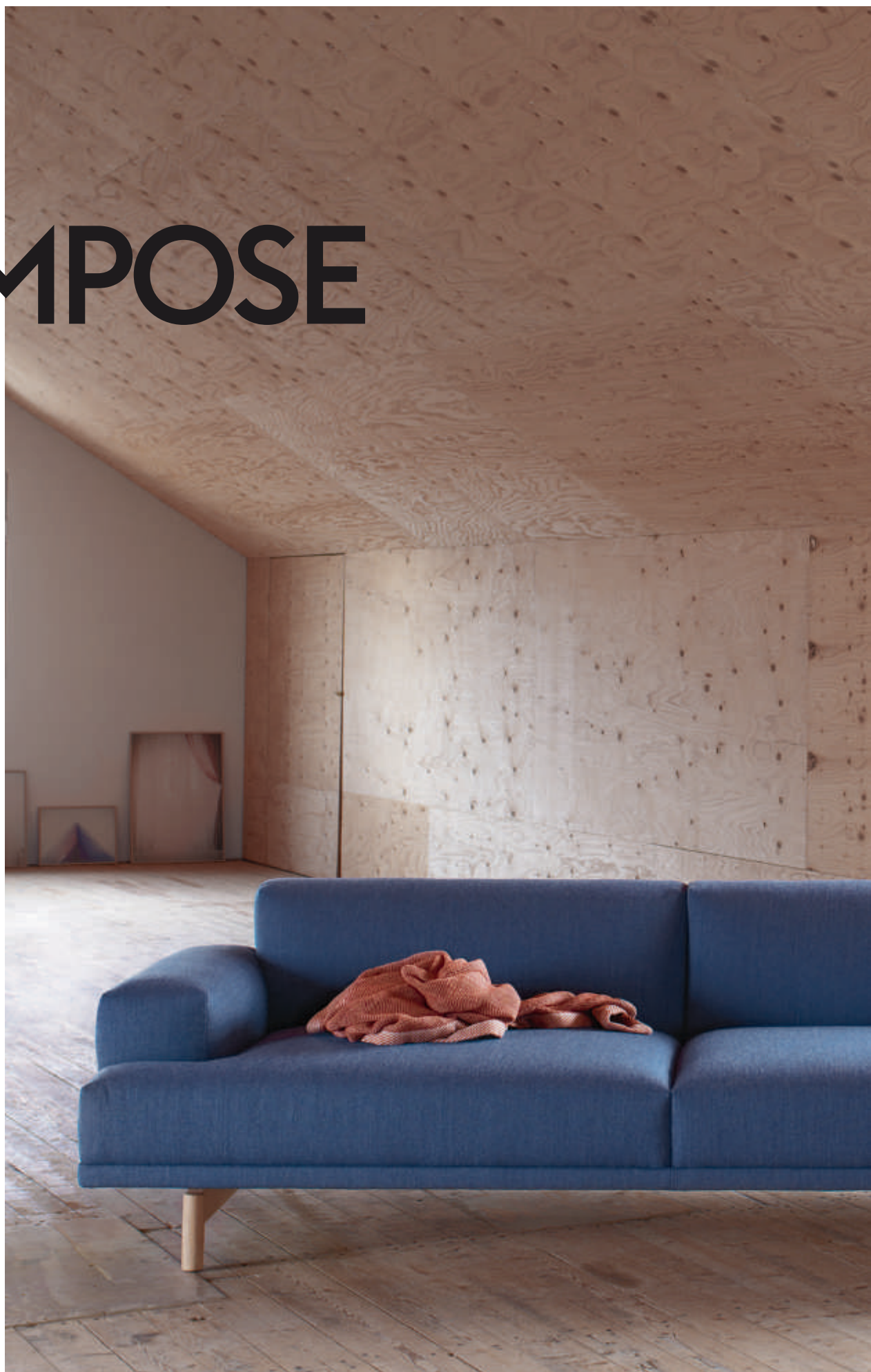

COMPOSE SOFA / Fiord 771
by Anderssen & Voll p. 40

RIPPLE THROW
by Margrethe Odgaard p. 55



FRAMED MIRROR
by Anderssen & Voll p. 52

COSY IN WHITE
by Harri Koskinen p. 50



FIVE POUF
by Anderssen & Voll p. 41

OPEN CANDELABRA
by Jens Fager p. 54

COMPILE SHELVING SYSTEM
by Cecilie Manz p. 42

COMPILE BOOKEND
by Cecilie Manz p. 53



From a distance, the RIPPLE throw looks monotone, but at close range, an optic ripple pattern appears and changes according to its drape and movement



RESTORE STORAGE



OUTLINE SOFA
by Anderssen & Voll p. 40

PLY RUG
by Margrethe Odgaard p. 55

AROUND COFFEE TABLE
by Thomas Bentzen p. 41

GRAIN LAMP
by Jens Fager p. 49



FIBER ARMCHAIR
by Iskos-Berlin p. 44

70/70 TABLE
by TAF Architects p. 48

GRAIN LAMP
by Jens Fager p. 49



Inspired by the shadow play of layers, the **FOLDED** shelves are based on a simple bending technique of a single sheet of metal



E27 lamp is a striking naked bulb that plays with the subtle aesthetic and simplicity of industrial design. The lamp can be used as a single light source, in pairs, rows or even in clusters



OSLO SOFA & FIVE POUF
by Anderssen & Voll p. 40

AROUND COFFEE TABLE
by Thomas Bentzen p. 41

VARJO RUG
by Tina Ratzer p. 55

PUSH MUGS
by Mette Duedahl p. 53



FRAMED MIRROR
by Anderssen & Voll p. 52

STACKED STORAGE SYSTEM
by Julien De Smedt p. 42

PLY RUG
by Margrethe Odgaard p. 55

AMBIT LAMP
By TAF Architects p. 49



ELEVATED VASE



STACKED STORAGE SYSTEM
by Julien De Smedt p. 42

OSLO SOFA
by Anderssen & Voll p. 40

CONTROL LAMP
by TAF Architects p. 50

PLY RUG
by Margrethe Odgaard p. 55



LEAN LAMP

23



COVER is born from a desire to create a comfortable and contemporary armchair in wood. The result is a light, yet strong armchair, playing with and taking the molded veneer to its extreme



STACKED STORAGE SYSTEM
by Julien De Smedt p. 42

VARJO RUG
by Tina Rätzer p. 55

CORKY DRINKING GLASSES
by Andreas Engesvik p. 53



REST SOFA
by Anderssen & Voll p. 41

AIRY COFFEE TABLE
by Cecilie Manz p. 41

PLY RUG
by Margrethe Odgaard p. 55

LEAN WALL LAMP
by Claesson Koivisto Rune p. 51



THE DOTS

COAT HOOKS



CONTROL lamp is a unique and playful lamp with references to hi-fi and industrial machinery. The light and dimmer is controlled by a switch, referencing volume controls



FIBER SIDE CHAIR
by Iskos-Berlin p. 44

LEAF TABLE LAMP
by Broberg & Ridderstråle p. 51



BASE TABLE
by Mika Tolvanen p. 48

NERD CHAIR
by David Geckeler p. 43

SILENT VASE
by Andreas Engesvik p. 54

UNDER THE BELL LAMP
by Iskos-Berlin p. 49



VISU CHAIR



The composition of the PULL lamp provides the lamp with a unique personality that is both organic and distinctively true to its Scandinavian design heritage



BASE TABLE
by Mika Tolvanen p. 48

AMBIT LAMP
by TAF Architects p. 49

FIBER ARMCHAIR
by Iskos-Berlin p. 44

NERD CHAIR
by David Geckeler p. 43



The UNFOLD lamp brings a new perspective to the classic and sought after, industry lamp. The soft silicone rubber gives the lamp its modern and warm personality



REST SOFA / Fiord 45I
by Anderssen & Voll p. 41

OSLO BENCH
by Anderssen & Voll p. 40

FOLDED SHELVES
by Johan van Hengel p. 53

WORKSHOP CHAIR
by Cecilie Manz p. 45



NERD BAR STOOL
by David Geckeler p. 43

GRAIN LAMP
by Jens Fager p. 49

CORKY CARAFE & GLASSES
by Andreas Engesvik p. 53

CRUSHED BOWL
by Julien de Smedt p. 54



37

REFLECT SIDEBOARD

RESTORE ROUND BASKET & TRAY
by Mika Tolvanen p. 52

REFLECT SIDEBOARD
by Søren Rose Studio p. 43

FLUID LAMP
by Claesson Koivisto Rune p. 50

38



AMBIT is a timeless and versatile pendant with a strong character. The dynamic between linear and rounded shapes creates the attractive outline of the lamp

FURNITURE
40 – 48

LIGHTING
49 – 51

ACCESSORIES
52 – 55

OUTLINE SOFA

by Anderssen & Voll

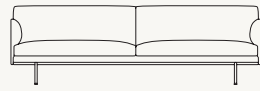

220 cm / 86.75"

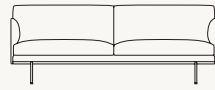

170 cm / 67"



Other textiles available upon request

MATERIAL

Powder coated aluminum legs. Wood and steel construction. Cold foam and feather filling. All textiles from Kvadrat or Arve. Leather from Camo Leathers.

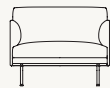

88 cm / 34.75"

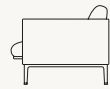

69,5 cm / 27.5"
SH 40 cm / 15.75"

84 cm / 33"

COMPOSE SOFA

by Anderssen & Voll

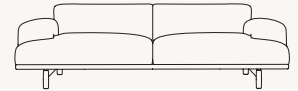

240 cm / 94.5"

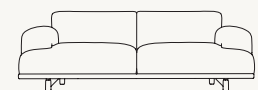

200 cm / 78.75"

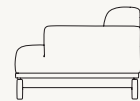

69 cm / 27.25"
SH 38 cm / 15"

94 cm / 37"

Textile



Other textiles available upon request

Legs



MATERIAL

Wooden frame and cold-foam filling. Wooden legs.

CONNECT MODULAR SOFA

by Anderssen & Voll

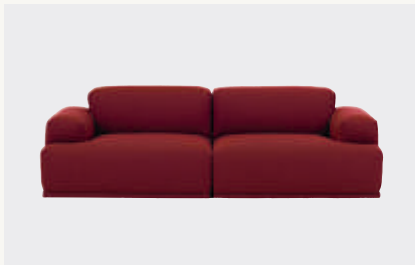

92 cm / 36.25"

117 cm / 46"

117 cm / 46"



92 cm / 36.25"

117 cm / 46"

92 cm / 36.25"



92 cm / 36.25"

92 cm / 36.25"

117 cm / 46"



92 cm / 36.25"

117 cm / 46"

117 cm / 46"



92 cm / 36.25"

92 cm / 36.25"



150 cm / 59"

117 cm / 46"

117 cm / 46"

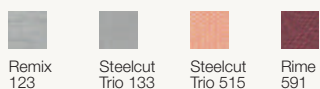

Other textiles available upon request

MATERIAL

Cold foam, wooden frame. All textiles from Kvadrat and Arve

OPTIONS

Combine your sofa setup from 11 different modules

OSLO SOFA

by Anderssen & Voll

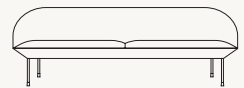

200 cm / 78.75"

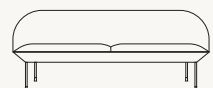

150 cm / 59"



78 cm / 30.75"
SH 45 cm / 17.75"

80 cm / 31.5"

73 cm / 28.75"

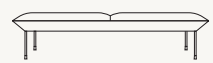

150 cm / 59"

45 cm / 17.75"

73 cm / 28.75"

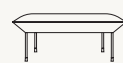

100 cm / 39.5"



45 cm / 17.75"

73 cm / 28.75"

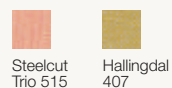
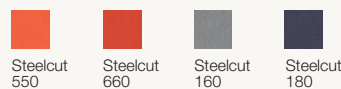

Other textiles available upon request

MATERIAL

Inner frame of steel, legs of aluminum w. powder-coated surface, casted foam. All textiles from Kvadrat

REST SOFA
by Anderssen & Voll

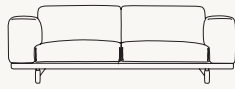

260 cm / 102.5"



200 cm / 78.75"



72 cm / 28.75"
SH 42 cm / 16.5"

92 cm / 36.25"

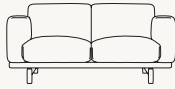

165 cm / 65"

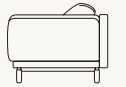

72 cm / 28.75"
SH 42 cm / 16.5"

87 cm / 34.25"



42 cm / 16.5"

100 cm / 39.5" 80 cm / 36.25"

Textile

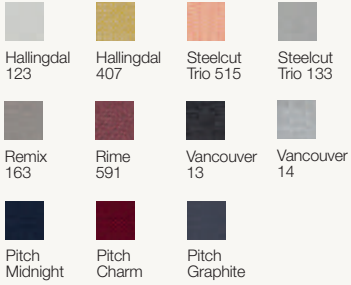

Other textiles available upon request

Legs



MATERIAL

Steel base, wooden frame, cold foam and feather filling. All textiles from Kvadrat, Arve and Febrik.

FIVE POUF
by Anderssen & Voll

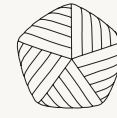

88 cm / 34.5"



45 cm / 17.75"

53 cm / 21"



Other textiles available upon request

MATERIAL

Wooden frame and molded foam
All textiles from Kvadrat

AIRY COFFEE TABLE
by Cecilie Manz

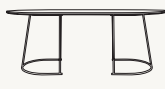

120 cm / 47.25"



41,2 cm / 16.25"

65 cm / 25.5"



MATERIAL

Plywood tabletop, powder coated solid steel frame

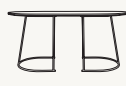

88 cm / 34.5"



37,2 cm / 14.5"

51,5 cm / 20.25"



37,2 cm / 14.5"

68 cm / 26.75" 44 cm / 17.25"



37,2 cm / 14.5"

39,5 cm / 15.5" 44 cm / 17.25"

AROUND COFFEE TABLE
by Thomas Bentzen



36 cm / 14.25"

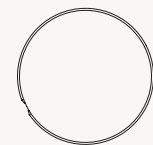

Ø 95 cm / 37.5"



36 cm / 14.25"

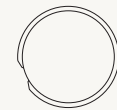

Ø 72 cm / 28.25"

MATERIAL

Tabletop made from ash or oak plywood or MDF.
Legs made from solid lacquered ash or oak



46 cm / 18"



Ø 45 cm / 17.75"

COMPILE SHELVING SYSTEM
by Cecilie Manz



Grey

MATERIAL
Powder coated steel

OPTION
Build personalized systems by assembling shelves with 3 sizes of dividers or choose between 8 prearranged solutions

Shelf

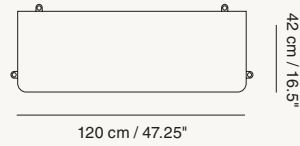

Dividers

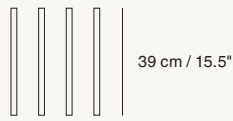

Essentials Pack



Prearranged configurations

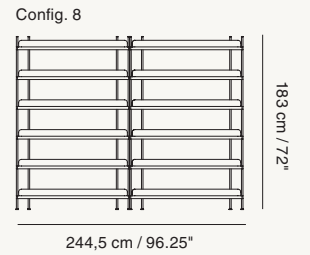
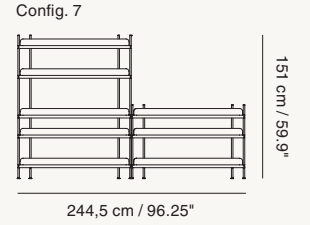
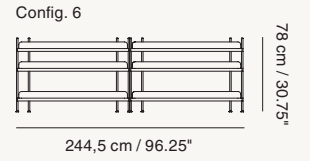
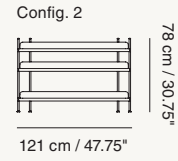
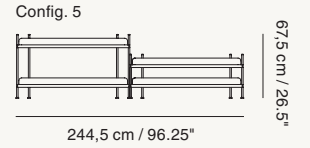
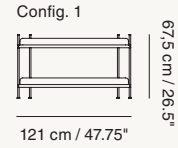

STACKED STORAGE SYSTEM
by Julien de Smedt

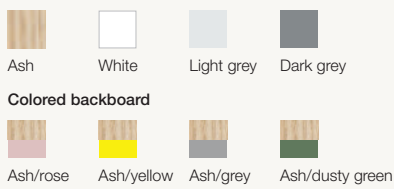

MATERIAL
Ash veneer, white, light grey or dark grey painted MDF

EXTRA
Stacked clips, set of five, available in white, grey, yellow, green or dusty green

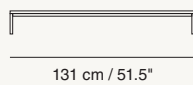
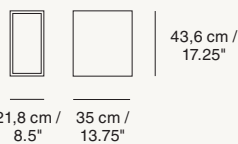
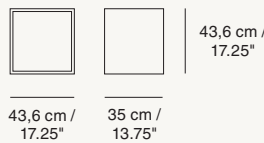
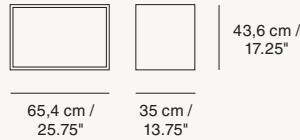

STACKED ACOUSTIC PANELS
by Julien de Smedt



MATERIAL
Polymer felt

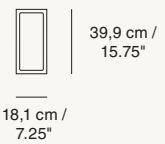
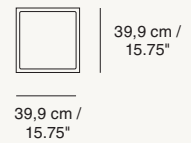
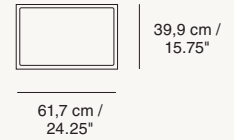

MINI STACKED STORAGE SYSTEM
by Julien de Smedt

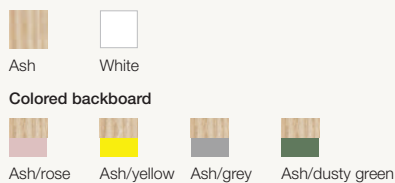

MATERIAL
Ash veneer or white painted MDF

EXTRA
Mini Stacked clips, set of five, available in white, grey, rose, yellow or dusty green

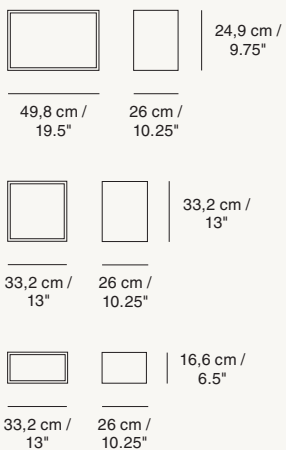

REFLECT SIDEBORD
by Søren Rose Studio



MATERIAL
Oak wood

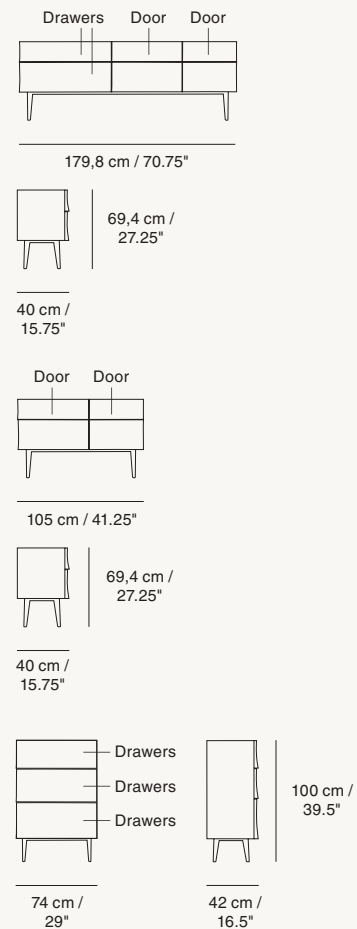

NERD CHAIR
by David Geckeler



MATERIAL
Natural oak, lacquered ash or beech



NERD BAR STOOL
by David Geckeler

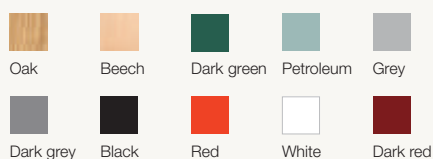

MATERIAL
Natural oak, lacquered ash or beech

OPTION
Bar stool in two seat heights - 65 cm or 75 cm



FIBER CHAIR TUBE & SLED BASE
by Iskos-Berlin



54,5 cm / 21.5"



76 cm / 30"
SH 45,5 cm / 18"

55 cm / 21.75"

Shell / Base



Textile upholstery / Base



Leather upholstery / Base



Front upholstery - Shell / Textile / Base



Remix 133/
white

Other textiles available upon request

MATERIAL

Form-pressed composition of plastic and up to 25 % wood fibers

FIBER CHAIR SWIVEL BASE
by Iskos-Berlin



54,5 cm / 21.5"



76,5 cm / 30"
SH 46 cm / 18"

55 cm / 21.75"

Shell / Base



Textile upholstery / Base

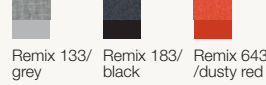

Leather upholstery / Base



Front upholstery - Shell / Textile / Base



Remix 133/
white

Other textiles available upon request

MATERIAL

Form-pressed composition of plastic and up to 25 % wood fibers

FIBER CHAIR WOOD BASE
by Iskos-Berlin



54,5 cm / 21.5"



76,5 cm / 30"
SH 46 cm / 18"

55 cm / 21.75"

Shell / Base



Ochre/
oak

Textile upholstery / Base

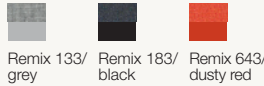

Leather upholstery / Base



Front upholstery - Shell / Textile / Base



White/remix
133/oak

Other textiles available upon request

MATERIAL

Form-pressed composition of plastic and up to 25 % wood fibers

FIBER SIDE CHAIR TUBE & SLED BASE
by Iskos-Berlin



51 cm / 20"



77 cm / 30.25"
SH 46 cm / 18"

53 cm / 21"

Shell / Base



Ochre/
black

Textile upholstery / Base

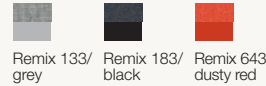

Leather upholstery / Base



Other textiles available upon request

MATERIAL

Form-pressed composition of plastic and up to 25 % wood fibers

53 cm / 21"

FIBER SIDE CHAIR SWIVEL BASE
by Iskos-Berlin



47,5 cm / 18.75"



53 cm / 21"

77 cm / 30.25"
SH 46 cm / 18"

Shell / Base



Textile upholstery / Base



Leather upholstery / Base



Other textiles available upon request

MATERIAL

Form-pressed composition of plastic and up to 25 % wood fibers

FIBER SIDE CHAIR WOOD BASE
by Iskos-Berlin



49,5 cm / 19.5"



53 cm / 21"

77 cm / 30.25"
SH 46 cm / 18"

Shell / Base



Textile upholstery / Base



Leather upholstery / Base

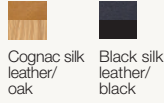

Other textiles available upon request

MATERIAL

Form-pressed composition of plastic and up to 25 % wood fibers

WORKSHOP CHAIR
by Cecilie Manz



40 cm / 15.75"



46 cm / 18"

79 cm / 31"
SH 45 cm / 17.75"

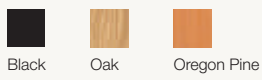

MATERIAL

Lacquered oak wood, matte clear oak or Oregon pine. Legs and frame made from solid wood. Back and seat made from veneer.

COVER CHAIR
by Thomas Bentzen



56,5 cm / 22.25"



46 cm / 18"

76 cm / 30"
SH 46 cm / 18"



Upholstered seat / Leather



Upholstered seat / Textile

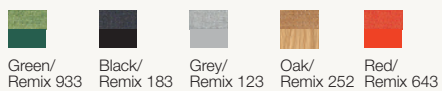

Other textiles available upon request

MATERIAL

Lacquered ash, oak, form-pressed veneer or beech

VISU CHAIR WOOD BASE
by Mika Tolvanen



46 cm / 18"



78,5 cm / 31"
SH 46 cm / 18"

51 cm / 20"



Shell / Base



Oak/
oak



White/
oak



Black/
black



Grey/
grey



Green/
green



White/
white



Rose/
rose



Dark grey/
dark grey



Dusty green/
dusty green

Textile upholstery / Base



Steelcut
Trio 515/
oak



Steelcut
Trio 133/
grey



Umami
743/
bluish black

Other textiles available upon request

MATERIAL

Form-pressed veneer

46

VISU CHAIR SLED BASE
by Mika Tolvanen



53 cm / 21"



78 cm / 30.75"
SH 45,5 cm / 18"



48 cm / 19"

Shell / Base



Black/
black



Grey/
grey



White/
white



Green/
green

Textile upholstery / Base



Steelcut
Trio 133/
grey

Other textiles available upon request

MATERIAL

Form-pressed veneer shell, brushed steel or powder-coated steel base

VISU CHAIR TUBE BASE
by Mika Tolvanen



44 cm / 17.25"



78 cm / 30.75"
SH 46,5 cm / 18"

50 cm / 19.75"

Shell / Base



Black/
black



Grey/
grey

MATERIAL

Lacquered ash or oak veneer shell, powder lacquered steel legs

VISU WIDE CHAIR WOOD BASE
by Mika Tolvanen



50 cm / 19.75"



78,5 cm / 31"
SH 45 cm / 17.75"

55 cm / 21.75"

Shell / Base



Oak/
oak



Black/
black

MATERIAL

Form-pressed veneer

VISU BAR STOOL
by Mika Tolvanen



42,7 cm / 16.75"



78,5 cm / 31"
SH 65 cm / 25.5"

42,3 cm / 16.75"

Shell / Base



OPTION

Bar stool in two seat heights - 65 cm or 75 cm

MATERIAL

Lacquered ash or oak veneer shell
Foot rest in lacquered or stainless steel



42,7 cm / 16.75"



88,5 cm / 34.75"
SH 75 cm / 29.5"

42,3 cm / 16.75"

VISU LOUNGE CHAIR
by Mika Tolvanen



60 cm / 23.5"



69 cm / 27.25"
SH 40 cm / 15.75"



51 cm / 20"

Shell / Base



Textile upholstery / Base



Other textiles available upon request

MATERIAL

Lacquered ash or oak veneer shell

RAW LOUNGE CHAIR
by Jens Fager



54 cm / 21.25"



76 cm / 30"
SH 46 cm / 18"

51 cm / 20"



MATERIAL

Hand-carved wood

70/70 TABLE
by TAF Architects



MATERIAL
Table top of pine plywood with linoleum (grey or black) laminate (white and light green) or oak veneer. Cast aluminum frame.

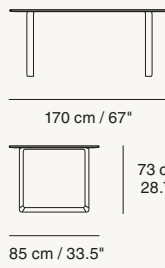
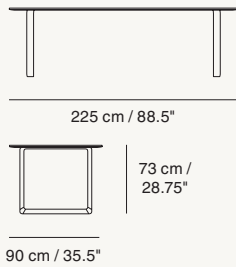
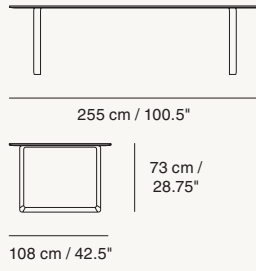

BASE TABLE REGTANGULAR & ROUND
by Mika Tolvanen

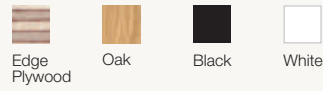

MATERIAL
Table top in laminate or linoleum (only black) and plywood edges. Table base in acrylic painted extruded aluminum

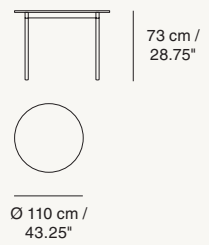
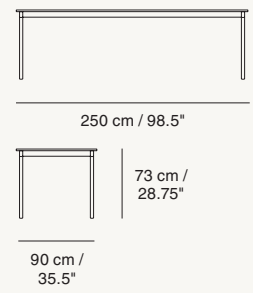
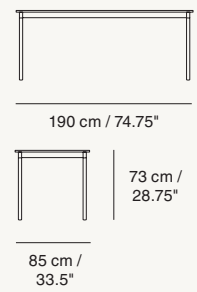
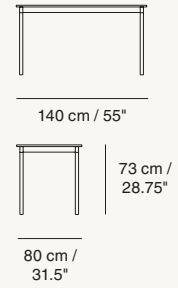

SPLIT TABLE
by Staffan Holm



MATERIAL
Oak

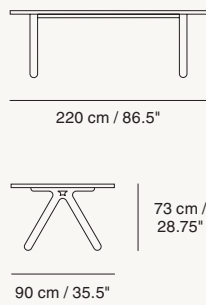

LIGHTING

E27 LAMP

by Mattias Ståhlbom

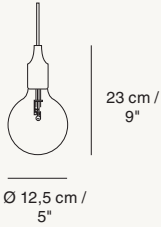
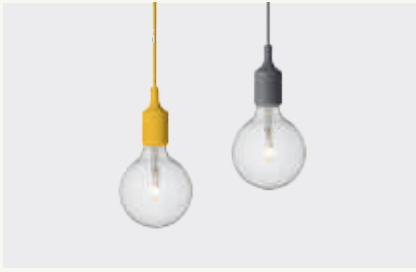

MATERIAL
Silicone rubber

LIGHT SOURCE
18W halogen bulb included

UNFOLD LAMP

by Form Us With Love

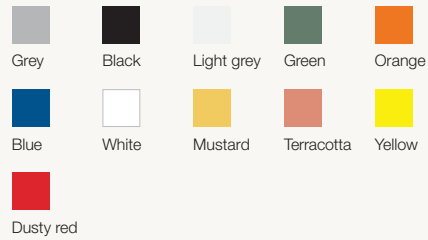
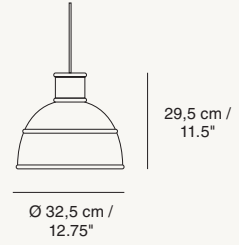

MATERIAL
Silicone rubber

LIGHT SOURCE
Max. 40W

AMBIT LAMP

by TAF Architects

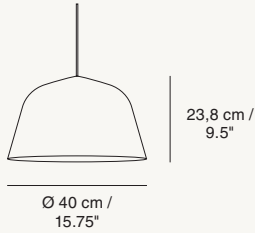
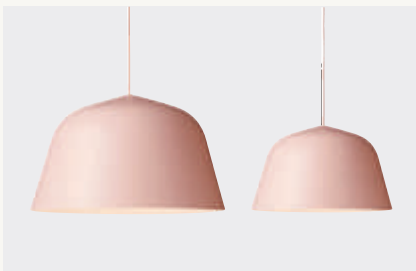

MATERIAL
Spun aluminum, rubber cord

LIGHT SOURCE
Max. 60W

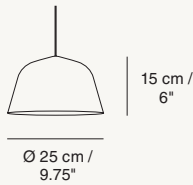

GRAIN LAMP

by Jens Fager

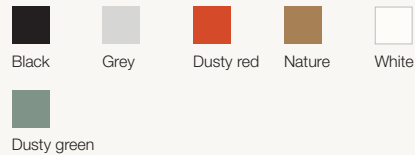

MATERIAL
Mixture of bamboo fibers & plastic, rubber cord

LIGHT SOURCE
4W LED bulb included

STUDIO LAMP

by Thomas Bernstrand

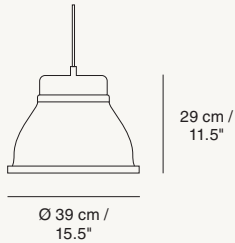

MATERIAL
Solid aluminum

LIGHT SOURCE
Max. 40W

UNDER THE BELL LAMP

by Iskos-Berlin

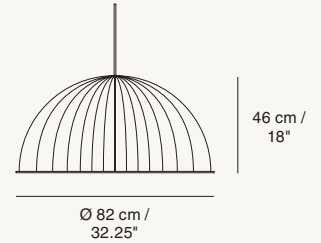

MATERIAL
Recycled PET felt, rubber cord

LIGHT SOURCE
30W bulb included

WOOD LAMP
by TAF Architects

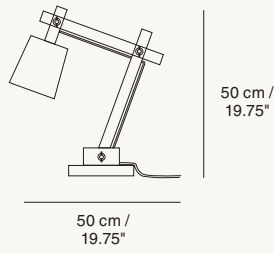

MATERIAL
Pine wood, rubber cord

LIGHT SOURCE
Max. 7W LED

FLUID LAMP
by Claesson Koivisto Rune

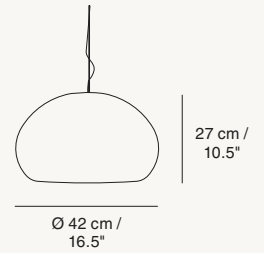

MATERIAL
White opal glass, matt finish

LIGHT SOURCE
Small max. 5W LED / Large max 60W

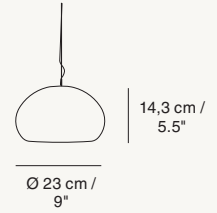

COSY IN WHITE LAMP
by Harri Koskinen

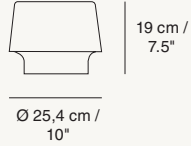
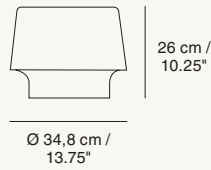

MATERIAL
Mouth blown glass

LIGHT SOURCE
Small max. 40W / large max. 60W

COSY IN GREY LAMP
by Harri Koskinen

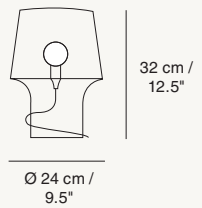

MATERIAL
Mouth blown glass

LIGHT SOURCE
Max. 60W

50

CONTROL LAMP
by TAF Architects

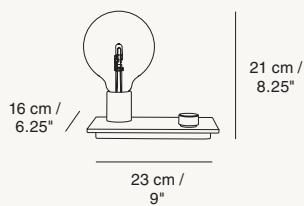
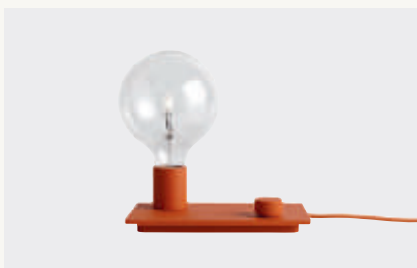

MATERIAL
Casted aluminum

LIGHT SOURCE
18W halogen bulb included

LEAN LAMP
by Claesson Koivisto Rune



MATERIAL
Casted aluminum, rubber cord

LIGHT SOURCE
LED 210-240V, 2W

LEAF TABLE LAMP

by Broberg & Ridderstråle



15,5 x 18,5 cm /
6" x 7.25"

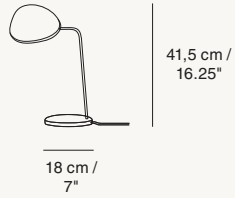

MATERIAL
Aluminum, brass

LIGHT SOURCE
8W LED bulb included

LEAF FLOOR LAMP

by Broberg & Ridderstråle



15,5 x 18,5 cm /
6" x 7.25"

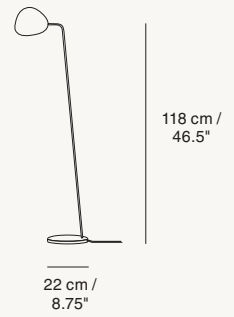

MATERIAL
Aluminum, brass

LIGHT SOURCE
8W LED bulb included

PULL LAMP

by Whatswhat



Ø 27 cm
H 24 cm /
Ø 10.5"
H 9.5"

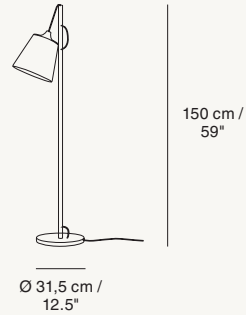

MATERIAL
Oiled oak wood, textile cord, textile covered plastic shade

LIGHT SOURCE
Max. 60 W

ACCESSORIES

FRAMED MIRROR by Anderssen & Voll



Frame / mirror glass



MATERIAL

Powder coated steel, mirror glass sheet

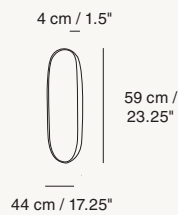
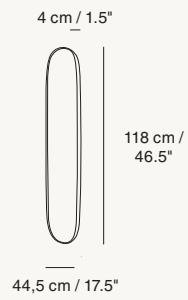

THE DOTS COAT HOOKS by Lars Tornøe

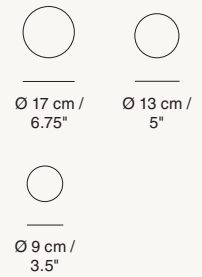

MATERIAL

Oak or ash wood. Colored versions in ash wood

OPTIONS

Available in single packages. Oak and black versions also available in gift boxes with 1 large, 1 medium and 3 small Dots

52

THE DOTS METAL COAT HOOKS by Lars Tornøe

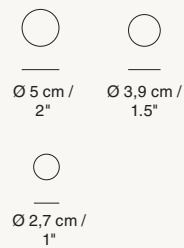
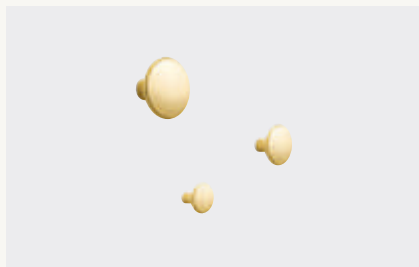

MATERIAL

Solid brass, solid aluminum or stainless steel with PVD vacuum treated surface

RESTORE BASKET by Mika Tolvanen

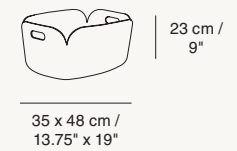

MATERIAL

Polymer felt

RESTORE ROUND BASKET by Mika Tolvanen

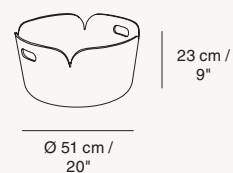

MATERIAL

Polymer felt

RESTORE TRAY by Mika Tolvanen

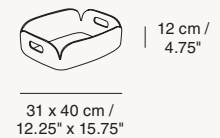

MATERIAL

Polymer felt

FOLDED SHELVES
by Johan Van Hengel

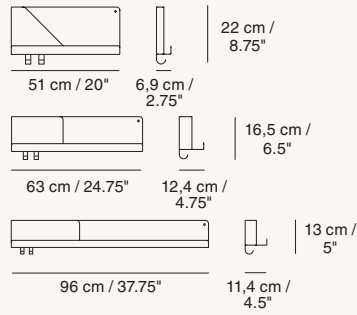
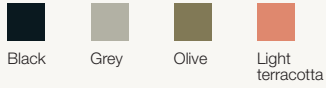
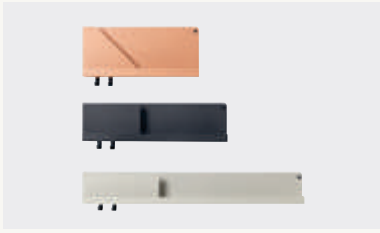

OPTION
All shelves come with 2 black bolts and 2 black hooks

MATERIAL
Acrylic powder coated steel

PUSH COFFEEMAKER & PUSH MUGS
by Mette Duedahl

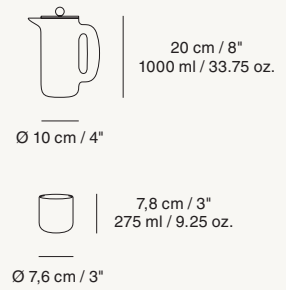

MATERIAL
Jug in stoneware, plastic lid, steel plunger

CORKY CARAFE & DRINKING GLASSES
by Andreas Engesvik

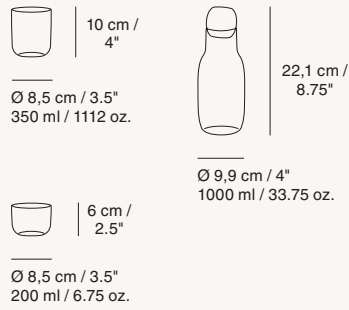

MATERIAL
Glass, cork

PLUS GRINDER / ONE SALT CELLAR
by Norway Says

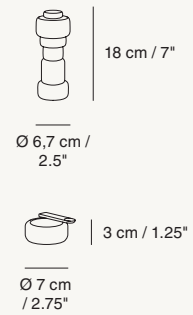

MATERIAL
Plus Grinder: Beech or maple wood stained and lacquered.

One Salt Cellar: Granite and wooden spoon

COMPILE BOOKEND
by Cecilie Manz

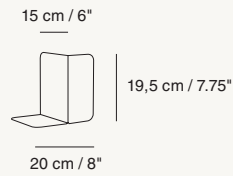
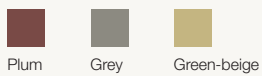

MATERIAL
Powder coated steel

GROOVE TRIVET
by Hallgeir Homstvedt

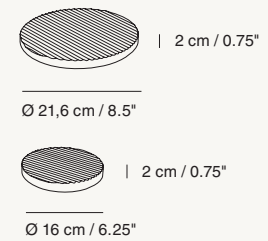
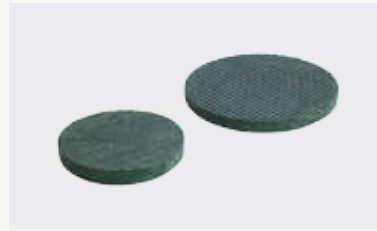

MATERIAL
Solid marble

GROOVE PLATE
by Hallgeir Homstvedt

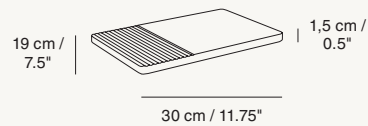

MATERIAL
Solid marble

EVERYDAY HOLY MUGS
by Ilkka Suppanen

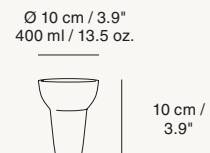

MATERIAL
Handcrafted new bone china White – glazed

CRUSHED BOWL
by JDS Architects

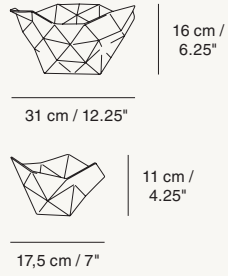

MATERIAL
Handcrafted fine porcelain, white – glazed

BALANCE VASE SET
by Hallgeir Homstvedt

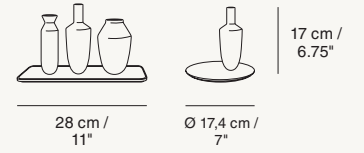

Black Nature Tangerine Block colour

MATERIAL
Powder coated steel trays, colored porcelain vases

SILENT VASE
by Andreas Engesvik



Grey Green Rose Clear

MATERIAL
Glass

ELEVATED VASE
by Thomas Bentzen

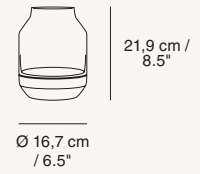

Green Grey Rose

MATERIAL
Mouth blown glass and solid ash wood

THE MORE THE MERRIER CANDLESTICK
by Louise Campbell

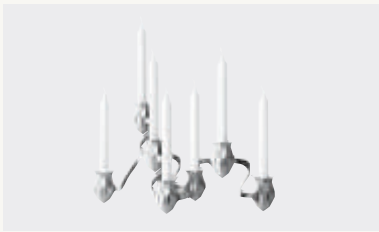

MATERIAL
Technical rubber and steel

OPTION
7 candleholders and 6 connectors

Grey Black White

GRIP CANDLESTICK
by Jens Fager

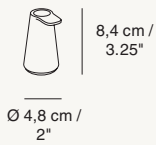

Dusty red Sand Anthracite

MATERIAL
Casted aluminum

OPEN CANDELABRA
by Jens Fager

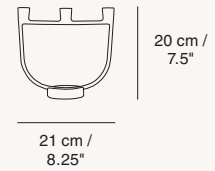

Black White Green Light terracotta

MATERIAL
Powder coated aluminum alloy

FLOAT CANDLESTICK
by Anderssen & Voll

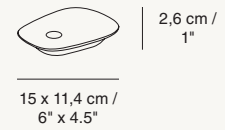

Sand Yellow Tangerine Light green

Anthracite

MATERIAL
Cast aluminum

PLY RUG
by Magrethe Odgaard

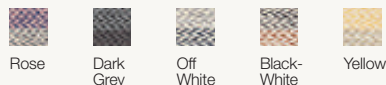

MATERIAL
100% New Zealand wool

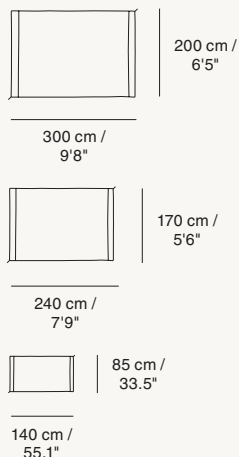

VARJO RUG
by Tina Ratzert

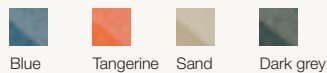
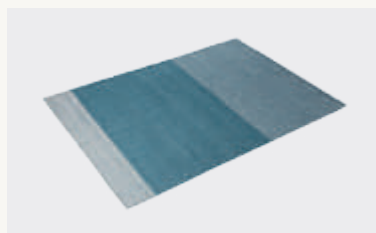

MATERIAL
100 % New Zealand wool

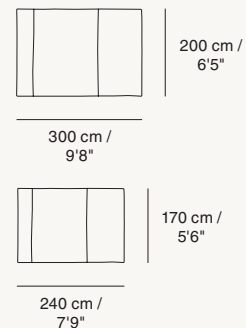

RIPPLE THROW
by Margrethe Odgaard

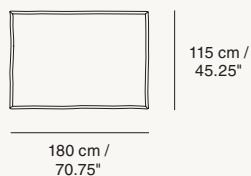
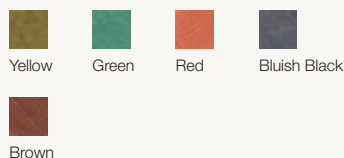

MATERIAL
100 % cotton

LOOM THROW
by Simon Key Bertman

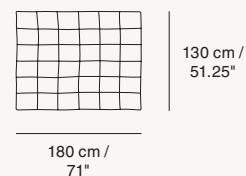
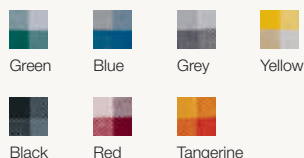

MATERIAL
100% cotton

TILE CUSHION
by Anderssen & Voll

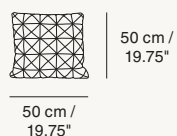

MATERIAL
Fabric: 100 % wool textile woven at Gudbrandsdalens Uldvarefabrik in Norway for Muuto.
Filling: Mix of feather and polyester

MINGLE CUSHION
by Thomas Bentzen

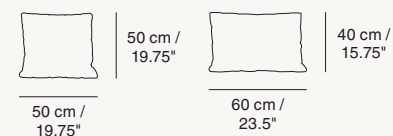
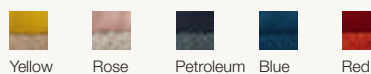

MATERIAL
Fabric: Coda / Steelcut
Mix of feather and polyester
All textiles from Kvadrat

HIDEAWAY TRASH BIN / LAUNDRY BASKET
by Mika Tolvanen



45 liters / 1522 oz.

MATERIAL
Rubber-coated plastic

MUUTO. COM

By the leading
contemporary designers:

Anderssen & Voll
Andreas Engesvik
Broberg & Ridderstråle
Cecilie Manz
Claesson Koivisto Rune
David Geckeler
Form Us With Love
Hallgeir Homstvedt
Harri Koskinen
Iskos-Berlin
Jakob Wagner

Jens Fager
Johan Van Hengel
Jonas Wagell
Julien De Smedt
Lars Tornøe
Louise Campbell
Margrethe Odgaard
Mattias Ståhlbom
Mette Duedahl
Mika Tolvanen
Norway Says

Ole Jensen
Simon Key Bertman
Staffan Holm
Søren Rose Studio
TAF Architects
Thomas Bentzen
Thomas Bernstrand
Tina Ratzer
Whatswhat

Styling:
Pernille Vest / All the way to Paris

Photography:
Petra Bindel / Mikkel Tjellesen / Gils

Printing:
Narayana Press

Subject to printer's errors