



Designers' index .....	03
My Zoo .....	04
Clouds .....	06
Birds .....	06
Puppy .....	08
Moments of Ingenuity .....	14
Sunny Day .....	14
Rocky .....	14
Dodo .....	16
Trioli .....	20
Julian .....	22
Pingy .....	24
Piedras .....	26
Little Flare .....	28
Seggiolina Pop .....	28
El Baúl .....	30
Puzzle Carpet .....	30, 50
Reiet .....	32
Alma .....	34
Linus .....	34
Mico .....	36
Flying Carpet .....	38
Bunky .....	40
Summer to Spring .....	42
Paradise Tree .....	44
My Space .....	46
My House .....	47
My Storage .....	48
Tuttifrutti .....	50
Ladrillos .....	52
Downtown .....	54
Nido .....	56
Villa Julia .....	58
My First Office .....	60
Football Tape .....	62
Technical Information .....	64
Index .....	83

## Designers' index



Eero Aarnio

Flying Carpet ..... p.38  
 Pingy ..... p.24  
 Puppy ..... p.08  
 Trioli ..... p.20



Rea Aarnio-Gibson

Sunny Day ..... p.14



Björn Dahlström

My House ..... p.47  
 My Space ..... p.46

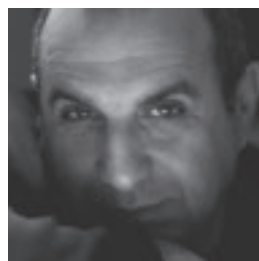

Stefano Giovannoni

Tuttifrutti ..... p.50



El Ultimo Grito

Mico ..... p.36  
 Summer to Spring ..... p.42

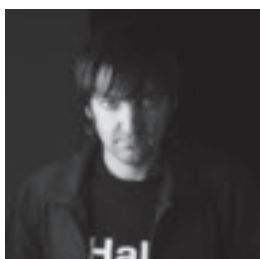

Martí Guixé

Football Tape ..... p.62  
 My First Office ..... p.60  
 My Zoo ..... p.04



Ineke Hans

My Storage ..... p.48



Enzo Mari

Seggiolina Pop ..... p.28



Javier Mariscal

Alma and Linus ..... p.34  
 El Baúl ..... p.30  
 Julian ..... p.22  
 Ladrillos ..... p.52  
 Nido ..... p.56  
 Piedras ..... p.26  
 Reiet ..... p.32  
 Villa Julia ..... p.58



Benedetta Mori Ubaldini

Birds ..... p.06  
 Clouds ..... p.06



Marc Newson

Bunky ..... p.40  
 Rocky ..... p.14



Satyendra Pakhalé

Puzzle Carpet ..... p.50



Oiva Toikka

Dodo ..... p.16  
 Downtown ..... p.54  
 Paradise Tree ..... p.44  
 Moments of Ingenuity ..... p.14

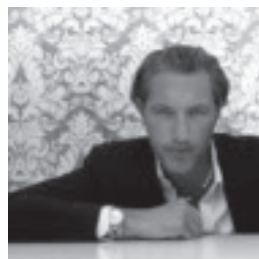

Marcel Wanders

Little Flare ..... p.28





Triennale Design Museum, Milan, Italy



Clouds and Birds  
design Benedetta Mori Ubaldini

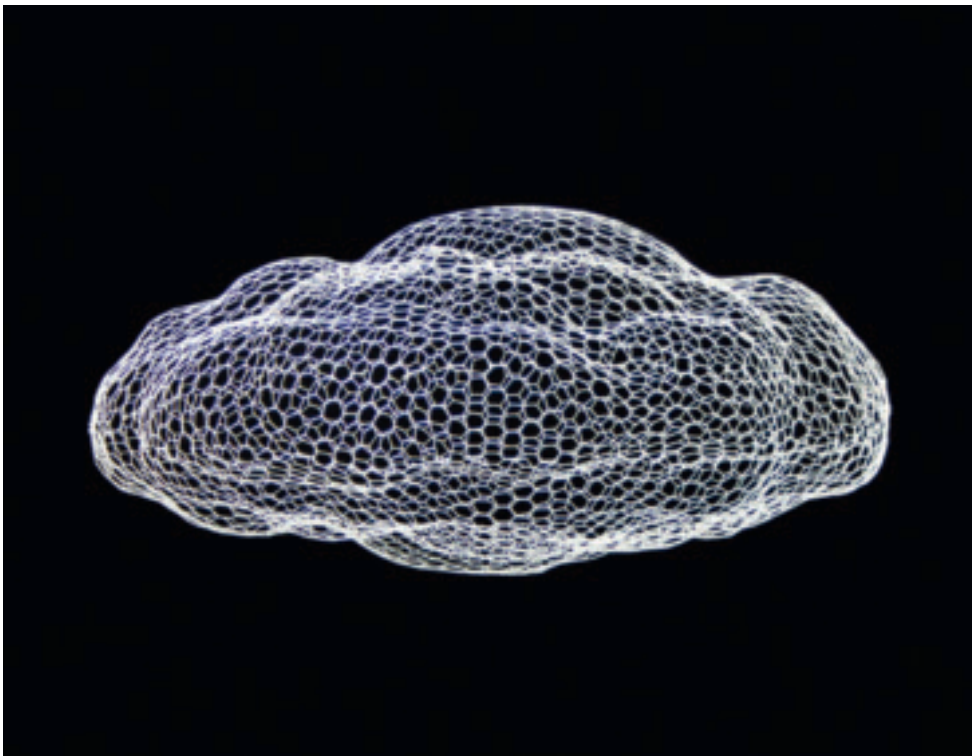

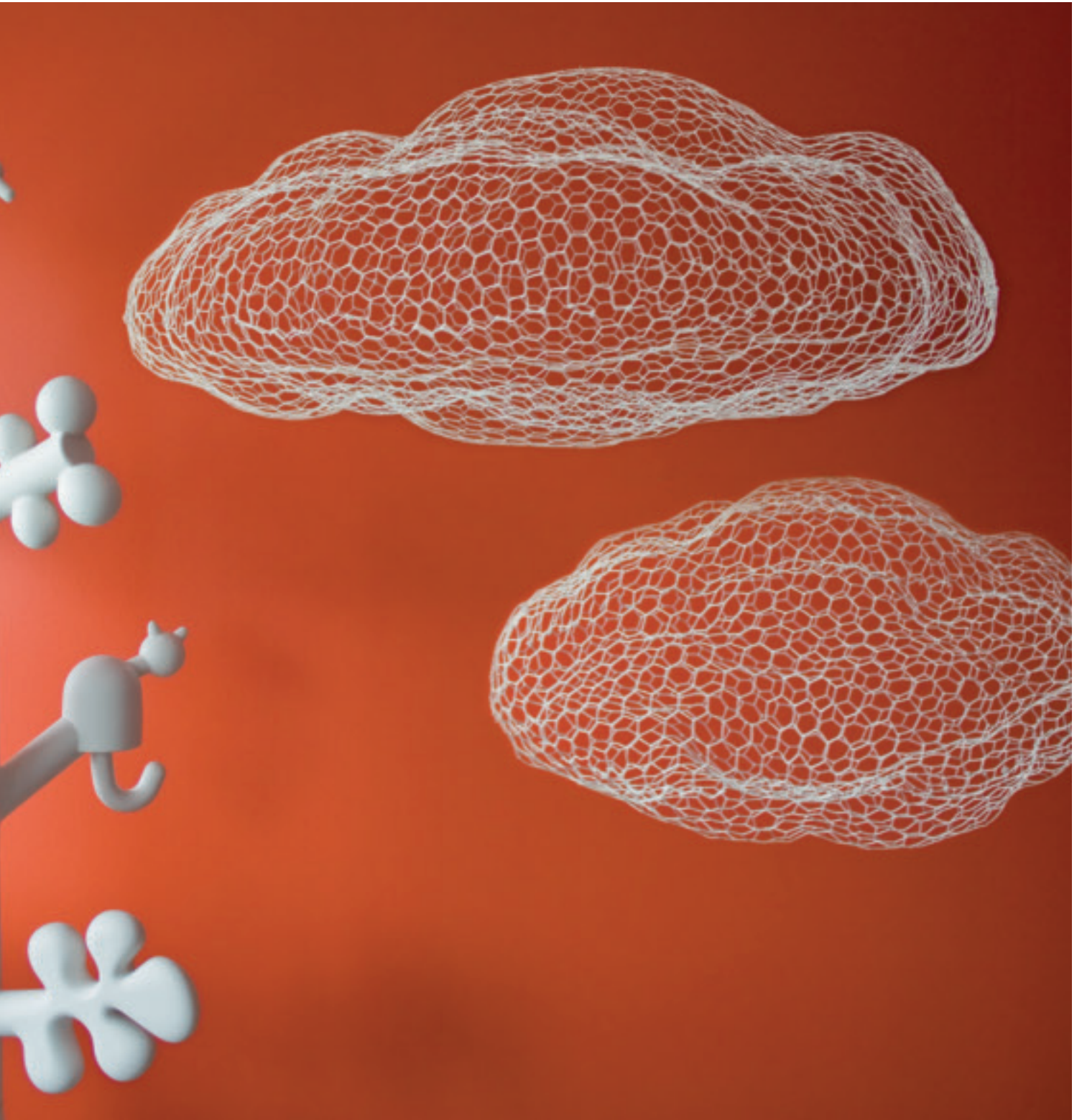

Puppy  
design Eero Aarnio



Studio Bee, Nara, Japan; project: Toshifumi Kitayoshi (Ash Planning Co.,Ltd.)





Tulum, Mexico



Mobilis, Rossens, Switzerland

Puppy  
design Eero Aarnio





Puppy  
design Eero Aarnio





Moments of Ingenuity serigraphy signed by Oiva Toikka  
Sunny Day design Rea Aarnio-Gibson



info p.82  
info p.67

# Rocky design Marc Newson

info p.67



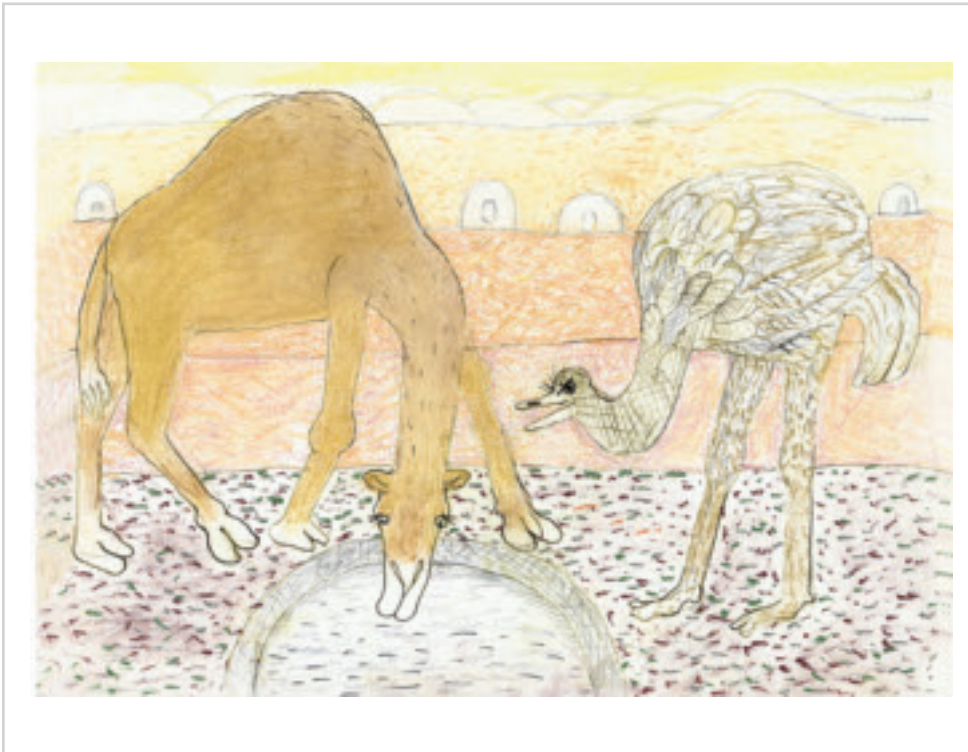





Dodo  
design Oiva Toikka





Trioli  
design Eero Aarnio





Nido Cecilia, Gruppo Danieli, Buttrio, Udine, Italy



Julian  
design Javier Mariscal



Me Too Exhibition, Treviso, Italy



Pingy  
design Eero Aarnio







Piedras  
design Javier Mariscal



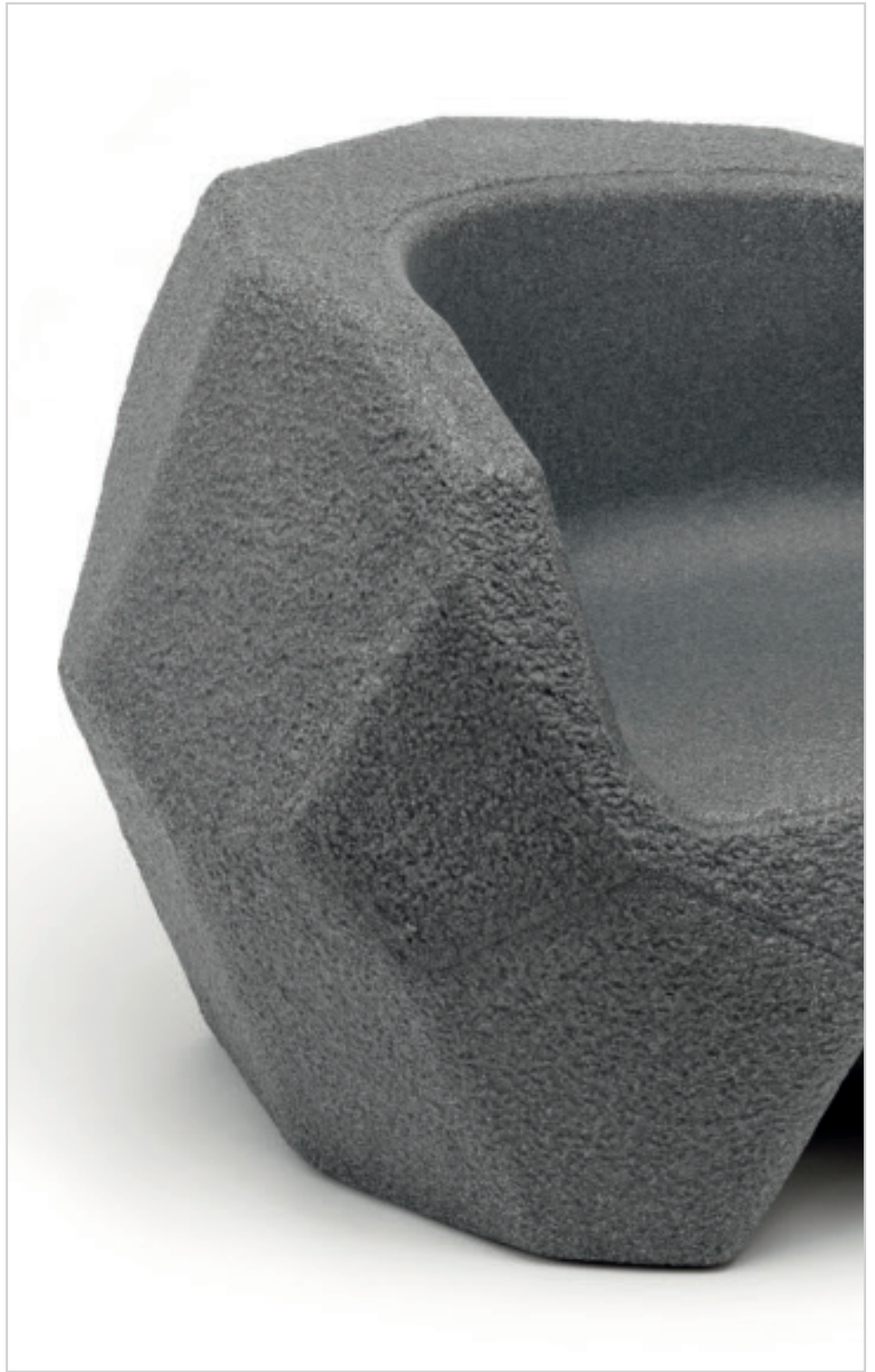

Little Flare  
design Mårceel wänders

info p.70

Seggiolina Pop  
design Enzo Mari





Seggiolina Pop design Enzo Mari  
El Baúl design Javier Mariscal

info p.71  
info p.71

My Storage design Ineke Hans  
Little Flare design mårcel wænder

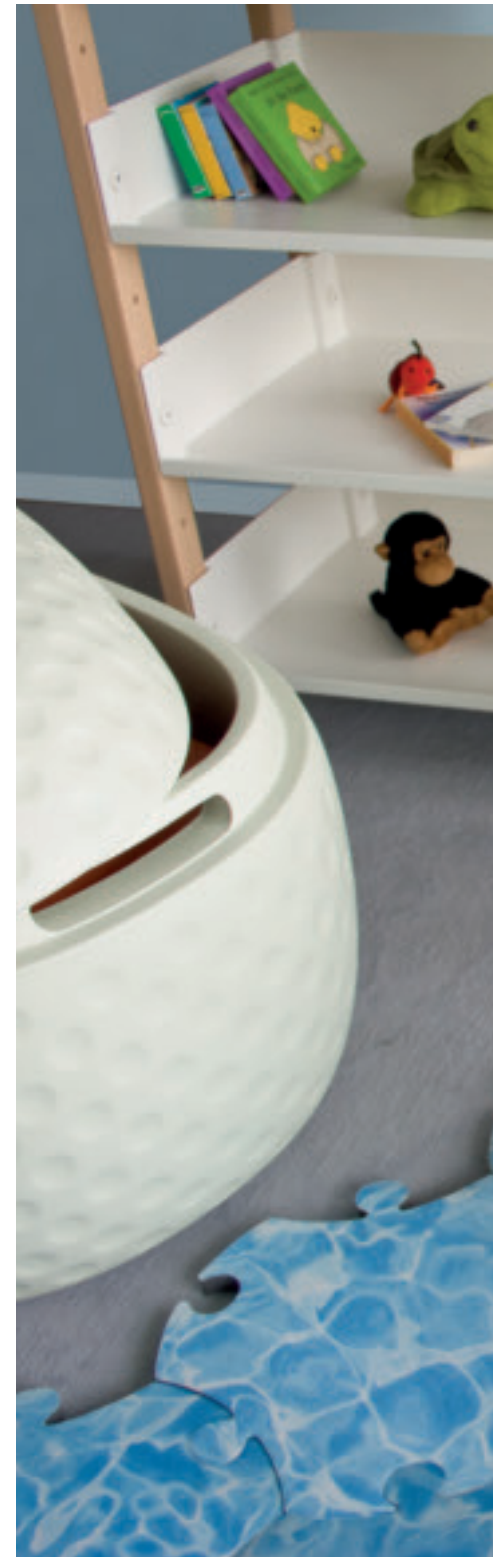

info p.78  
info p.70

# Puzzle Carpet design Satyendra Pakhalé

info p.72



Reiet  
design Javier Mariscal







Alma and Linus  
design Javier Mariscal





Nido Cecilia, Gruppo Danieli, Buttrio, Udine, Italy



Mico  
design El Ultimo Grito





Flying Carpet  
design Eero Aarnio

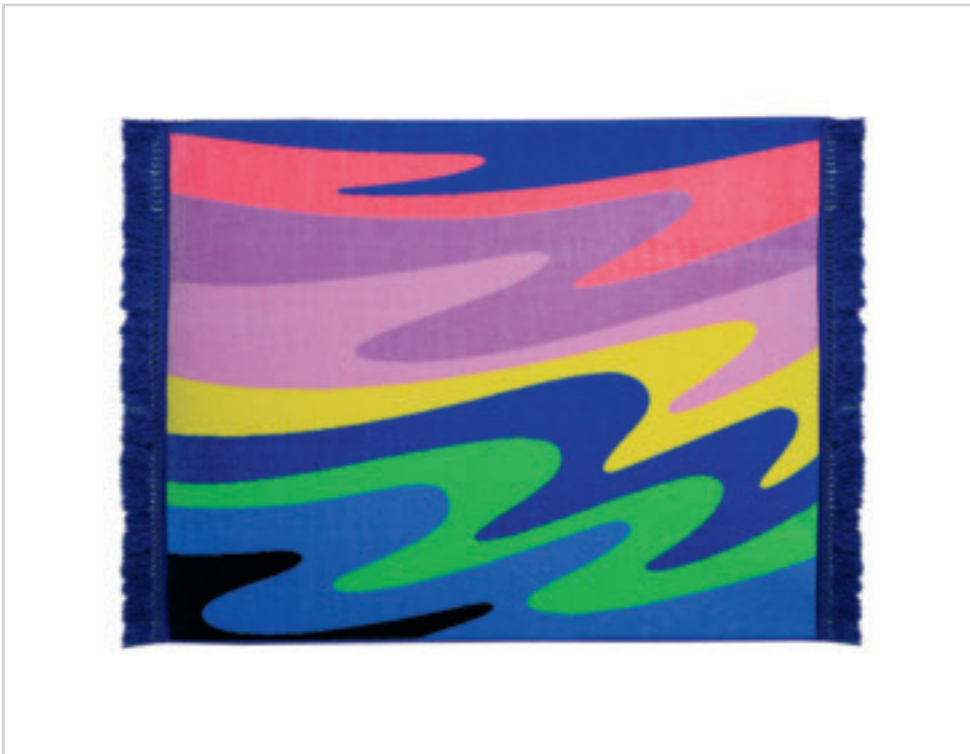



Bunky  
design Marc Newson







Summer to Spring  
design El Ultimo Grito





Paradise Tree  
design Oiva Toikka









My Storage  
design Ineke Hans

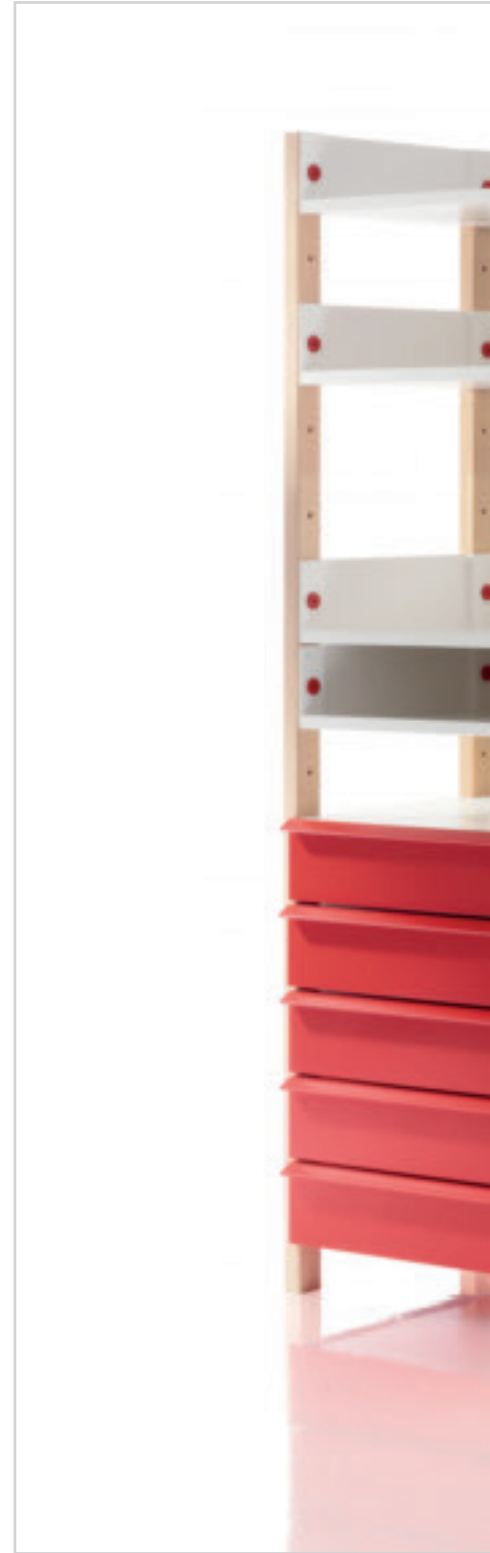





Tuttifrutti design Stefano Giovannoni  
Puzzle Carpet design Satyendra Pakhalé





Ladrillos  
design Javier Mariscal



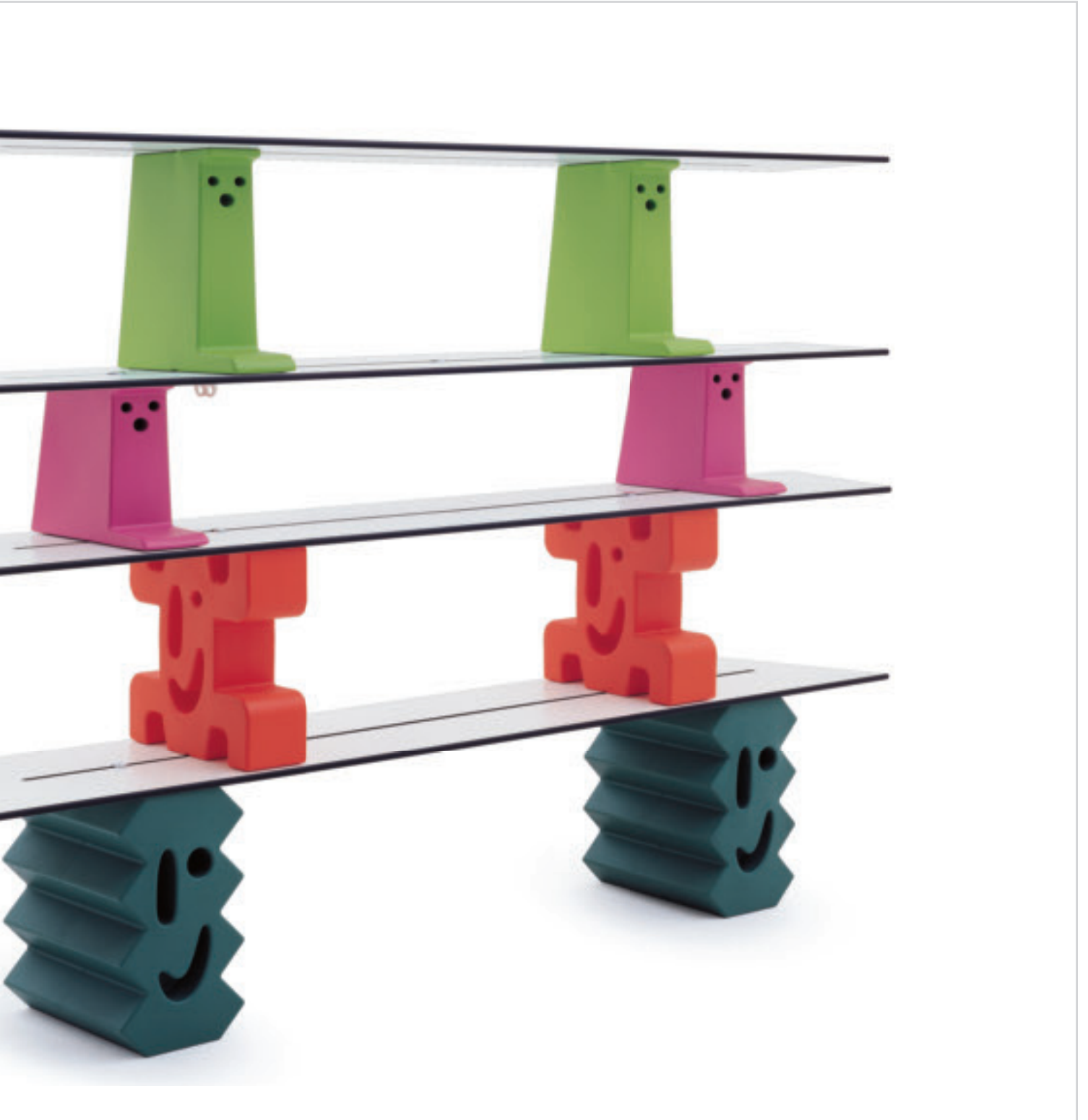

Downtown  
design Oiva Toikka





Nido  
design Javier Mariscal





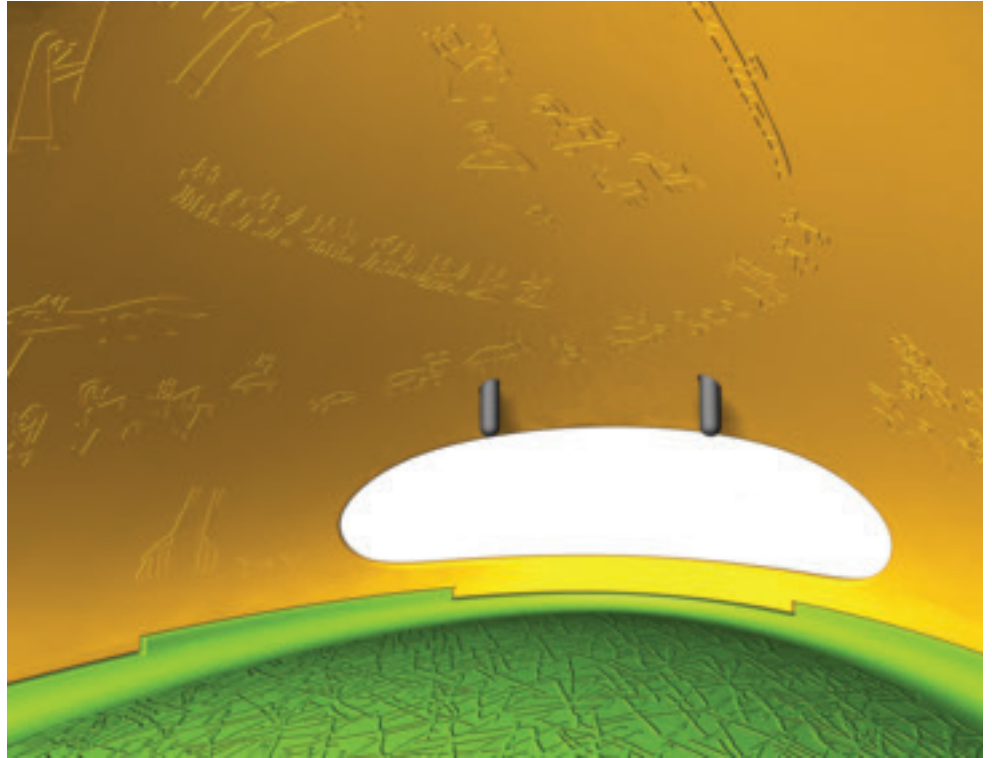

Villa Julia  
design Javier Mariscal

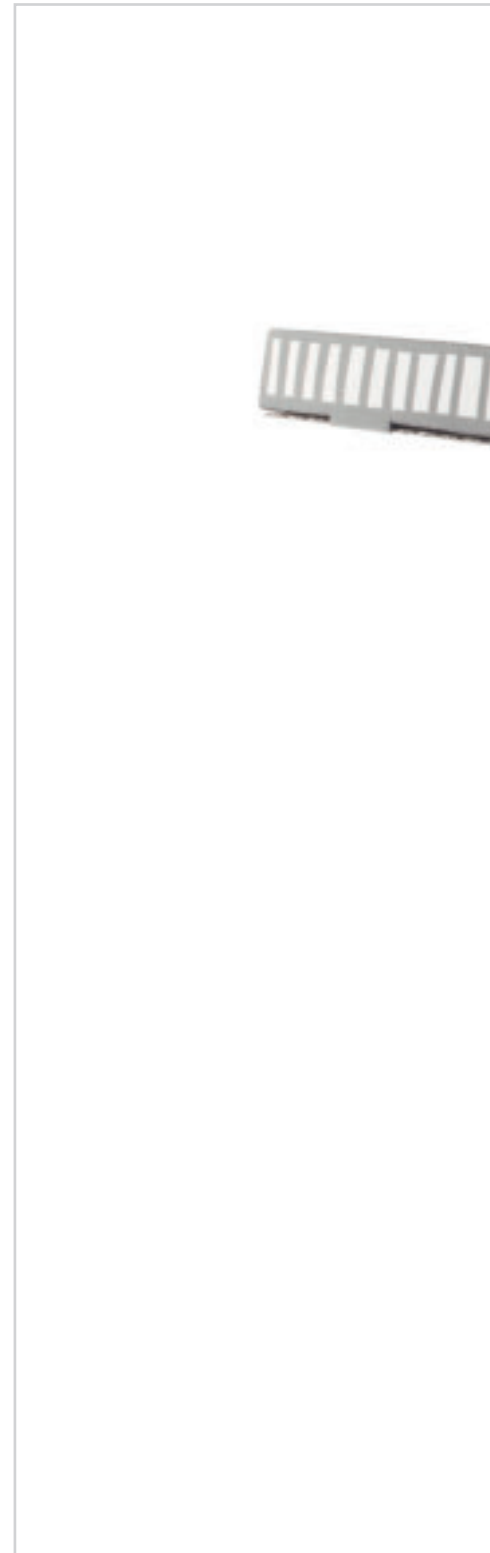



My First Office  
design Martí Guixé





Football Tape  
design Martí Guixé





## My ZOO design Martí Guixé • image p-04

Animal figures.  
Year of production: 2012.  
Material: cardboard.

Figuras de animales.  
Año de producción: 2012.  
Material: cartón.

Figures d'animaux.  
Année de production: 2012  
Matériaux: carton.

Tierfiguren.Erstproduktion: 2012.  
Material: Karton.

Anno di produzione: 2012.  
Materiale: cartone.

Figure di animali.

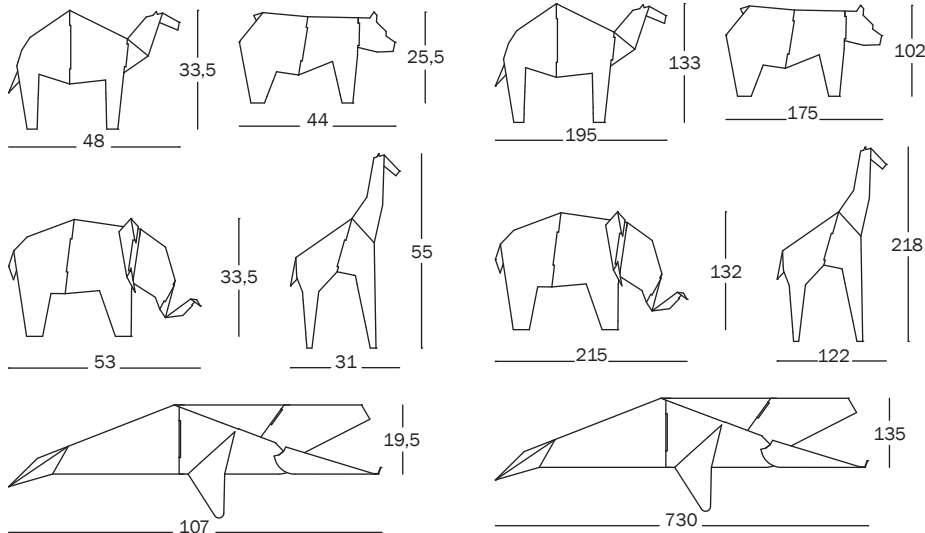

## Clouds design Benedetta Mori Ubaldini • image p-06

Clouds.  
Year of production: 2012.  
Material: metal mesh painted in epoxy resin. Supplied with hook for ceiling fixing.

Nubes.  
Año de producción: 2012.  
Material: Material: malla de alambre barnizada con pintura epoxi. Completas con gancho para fijar al techo.

Nuages.  
Année de production: 2012.  
Matériaux: haie métallique vernie en résine époxy. Fournies de crochet pour la fixation au plafond.

Wolken.  
Erstproduktion: 2012.  
Material: Maschendraht, epoxydackiert. Komplet mit Befestigungshaken zur Deckenmontage.

Nuvole.  
Anno di produzione: 2012.  
Materiale: rete metallica verniciata in resina epossidica. Completa di gancio di fissaggio a soffitto.

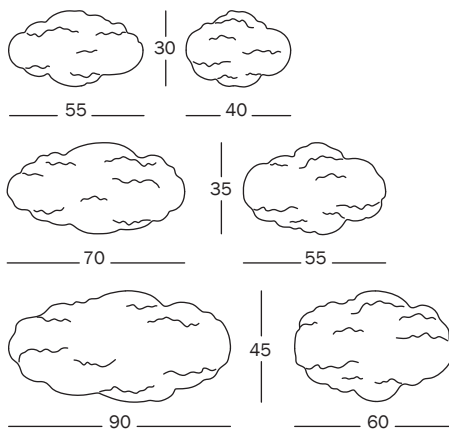

MATT COLOUR  
white 5110

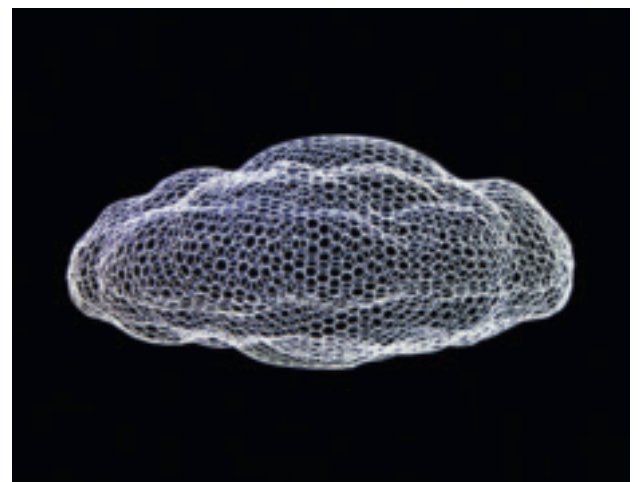



## Birds design Benedetta Mori Ubaldini • image p-06

Birds.  
Year of production: 2012.  
Material: metal mesh painted in epoxy resin. Supplied with hook for ceiling fixing.

Aves.  
Año de producción: 2012.  
Material: malla de alambre barnizada con pintura epoxi. Completas con gancho para fijar al techo.

Oiseaux.  
Année de production: 2012.  
Matériaux: haie métallique vernie en résine époxy. Fournis de crochet pour la fixation au plafond.

Vögel.  
Erstproduktion: 2012.  
Material: Maschendraht, epoxydlackiert. Komplett mit Befestigungshaken zur Deckenmontage.

Uccelli.  
Anno di produzione: 2012.  
Materiale: rete metallica verniciata in resina epossidica. Completa di gancio di fissaggio a soffitto.

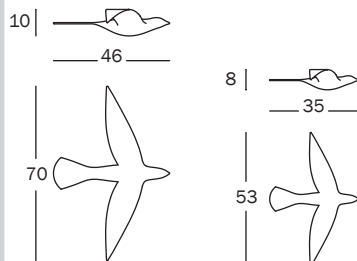

MATT COLOUR  
grey 5069



## Puppy design Eero Aarnio • image p-08

Abstract plastic dog.  
Year of production: 2005.  
Material: rotational-moulded polyethylene. Suitable for outdoor use.

Perro abstracto.  
Año de producción: 2005.  
Material: polietileno por moldeo rotacional. Apto para el exterior.

Chien abstrait en plastique.  
Année de production: 2005.  
Matériaux: polyéthylène moulé par rotation. Conçu pour l'extérieur.

Abstrakter Hund aus Kunststoff.  
Erstproduktion: 2005.  
Material: Polyäthylen. Hergestellt im Rotationsverfahren. Auch für den Aussenbereich geeignet.

Cane astratto.  
Anno di produzione: 2005.  
Materiale: polietilene stampato in rotazionale moulding. Adatto anche per esterni.

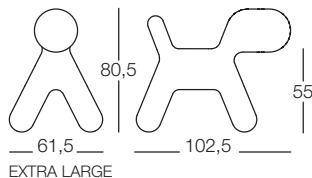
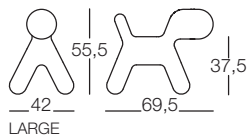
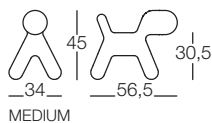
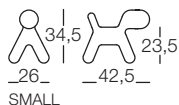

MATT COLOURS  
orange 1001 C  
green 1360 C  
white 1700 C



## Puppy design Eero Aarnio • image p-12

Abstract plastic dog.  
Year of production: 2009.  
Material: rotational-moulded polyethylene. Painted glossy.

Perro abstracto.  
Año de producción: 2009.  
Material: polietileno por moldeo rotacional. Barnizado brillante.

Chien abstrait en plastique.  
Année de production: 2009.  
Matériaux: polyéthylène moulé par rotation. Verni brillant.

Abstrakter Hund aus Kunststoff.  
Erstproduktion: 2009.  
Material: Polyäthylen. Hergestellt im Rotationsverfahren. Lackiert glänzend.

Cane astratto.  
Anno di produzione: 2009.  
Materiale: polietilene stampato in rotational moulding. Versione verniciata lucida.

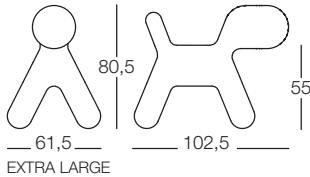
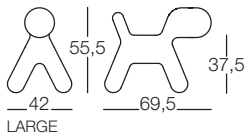
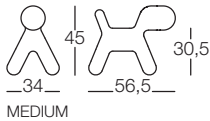
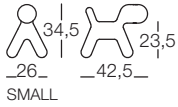

GLOSSY COLOURS  
 red 1109 C  
 white 1736 C  
 black 1763 C



## Puppy design Eero Aarnio • image p-12

Abstract plastic dog.  
Year of production: 2011.  
Material: rotational-moulded polycarbonate.

Perro abstracto.  
Año de producción: 2011.  
Material: policarbonato por moldeo rotacional.

Chien abstrait en plastique.  
Année de production: 2011.  
Matériaux: polycarbonate moulé par rotation.

Abstrakter Hund aus Kunststoff.  
Erstproduktion: 2011.  
Material: Polycarbonat. Hergestellt im Rotationsverfahren.

Cane astratto.  
Anno di produzione: 2011.  
Materiale: policarbonato stampato in rotational moulding.

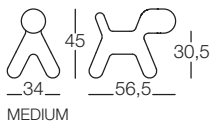

TRANSPARENT COLOUR  
 red 2512 TR



## Rocky design Marc Newson • image p-14

Rocking horse.  
Year of production: 2012.  
Material: rotational-moulded polyethylene. Rein in natural hemp rope.

Caballo balancín.  
Año de producción: 2012.  
Material: polietileno por moldeo rotacional. Rienda de cáñamo natural.

Cheval à bascule.  
Année de production: 2012.  
Matériaux: polyéthylène moulé par rotation. Rêne en corde de chanvre naturel.

Schaukelpferd.  
Erstproduktion: 2012.  
Material: Polyäthylen, hergestellt im Rotations-Verfahren. Zügel aus Natur-Hanf.

Cavallo a dondolo.  
Anno di produzione: 2012.  
Materiale: polietilene stampato in rotational moulding. Redine in corda di canapa naturale.

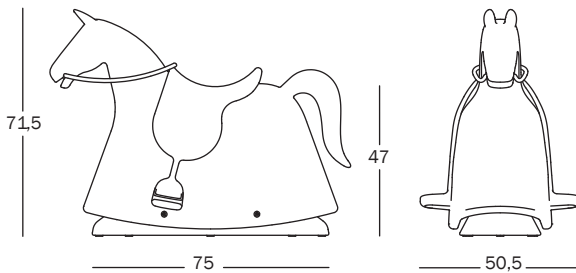

MATT COLOURS  

 brown 1069 C  
 white 1736 C  
 black 1768 C



## Sunny Day design Rea Aarnio-Gibson • image p-14

Carpet.  
Year of production: 2007.  
Material: coloured polyamide.

Alfombra.  
Año de producción: 2007.  
Material: poliamida de color.

Tapis.  
Année de production: 2007.  
Matériaux: polyamide coloré.

Teppich.  
Erstproduktion: 2007.  
Material: Polyamid, farbig.

Tappeto.  
Anno di produzione: 2007.  
Materiale: poliammide colorato.

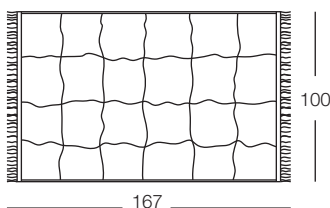

## Dodo design Oiva Toikka • image p-16

Rocking bird.  
Year of production: 2009.  
Material: rotational-moulded polyethylene. Suitable for outdoor use.

Ave mecedora.  
Año de producción: 2009.  
Material: polietileno por moldeo rotacional. Apto para el exterior.

Oiseau à bascule.  
Année de production: 2009.  
Matériaux: polyéthylène moulé par rotation. Conçu pour l'extérieur.

Schaukelvogel.  
Erstproduktion: 2009.  
Material: Polyäthylen. Hergestellt im Rotationsverfahren. Auch für den Aussenbereich geeignet.

Uccello a dondolo.  
Anno di produzione: 2009.  
Materiale: polietilene in rotational moulding. Adatto anche per esterni.

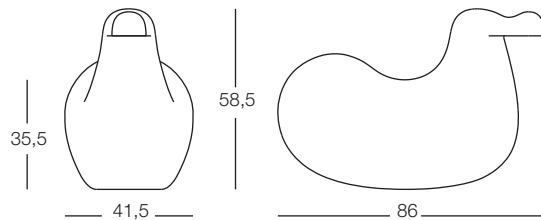

MATT COLOURS  

 red 1004 C  
 yellow 1025 C  
 blue 1252 C  
 white 1735 C



## Trioli design Eero Aarnio • image p-20

Children's chair.  
Year of production: 2005.  
Material: rotational-moulded polyethylene. Three different seat heights. It can also be used as a rocker. Suitable for outdoor use.

Silla para niños con tres posibles usos.  
Año de producción: 2005.  
Material: polietileno por moldeo rotacional. También se puede usar como mecedora. Apta para el exterior.

Chaise pour enfant.  
Année de production: 2005.  
Matériaux: polyéthylène moulé par rotation. Trois différentes hauteurs d'assise. La chaise peut être utilisée aussi comme cheval à bascule. Conçue pour l'extérieur.

Kinderstuhl.  
Erstproduktion: 2005.  
Material: Polyäthylen. Hergestellt im Rotationsverfahren. Der Stuhl kann auch als Wippe benutzt werden. Auch für den Aussenbereich geeignet.

Sedia per bambini a tre usi: alta, bassa e cavallo a dondolo.  
Anno di produzione: 2005.  
Materiale: polietilene stampato in rotational moulding. Adatta anche per esterni.

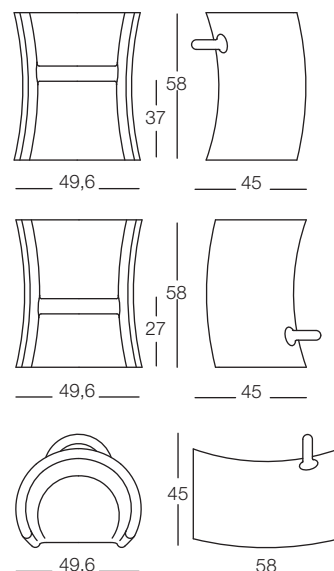

MATT COLOURS  

 red 1004 C  
 blue 1252 C  
 yellow 1665 C  
 white 1700 C



## Julian design Javier Mariscal • image p-22

Children's chair.  
Year of production: 2005.  
Material: rotational-moulded polyethylene. Suitable for outdoor use.

Silla para niños.  
Año de producción: 2005.  
Material: polietileno por moldeo rotacional. Apta para el exterior.

Chaise pour enfant.  
Année de production: 2005.  
Matériaux: polyéthylène moulé par rotation. Conçue pour l'extérieur.

Kinderstuhl.  
Erstproduktion: 2005.  
Material: Polyäthylen. Hergestellt im Rotationsverfahren. Auch für den Aussenbereich geeignet.

Sedia per bambini.  
Anno di produzione: 2005.  
Materiale: polietilene stampato in rotational moulding. Adatta anche per esterni.

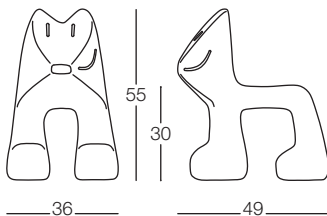

MATT COLOURS  
 red 1122 C  
 green 1290 C  
 yellow 1665 C  
 white 1735 C



## Pingy design Eero Aarnio • image p-24

Penguin.  
Year of production: 2011.  
Materials: rotational-moulded polyethylene.

Pingüino.  
Año de producción: 2011.  
Materiales: polietileno por moldeo rotacional.

Pingouin.  
Année de production: 2011.  
Matériaux: polyéthylène moulé par rotation.

Pinguin.  
Erstproduktion: 2011.  
Materialien: Polyäthylen. Hergestellt im Rotationsverfahren.

Pinguino.  
Anno di produzione: 2011.  
Materiale: polietilene stampato in rotational moulding.

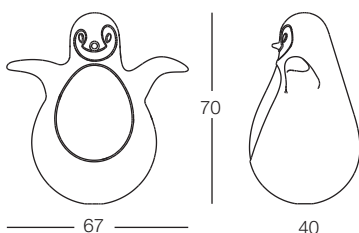

MATT COLOUR  
 black 1763 C



## Piedras design Javier Mariscal • image p-26

Low chair, bench and low table.  
Year of production: 2006.  
Material: rotational-moulded polyethylene. Suitable for outdoor use.

Sillón, sofá y mesita.  
Año de producción: 2006.  
Material: polietileno por moldeo rotacional. Apto para el exterior.

Fauteuil, canapé et petite table.  
Année de production: 2006.  
Matériaux: polyéthylène moulé par rotation. Conçus pour l'extérieur.

Niedriger Stuhl, Sofa und niedriger Tisch.  
Erstproduktion: 2006.  
Material: Polyäthylen. Hergestellt im Rotationsverfahren. Auch für den Aussenbereich geeignet.

Famiglia di sedute (a 1 e 2 posti) e tavolino di appoggio.  
Anno di produzione: 2006.  
Materiale: polietilene stampato in rotazionale moulding. Adatta anche per esterni.

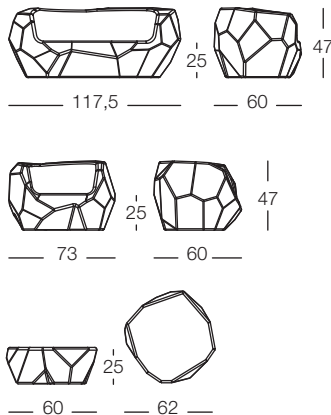

MATT COLOUR  
grey anthracite 1407 C



## Little Flare design mærcel wænders • image p-28

Children's table.  
Year of production: 2005.  
Material: legs in standard injection-moulded polycarbonate transparent clear. Tops in MDF with white polymeric cover. Patterned tops also available. Pen holders in ABS. Sketch book available with patterns to be completed and coloured.

Mesa de niños.  
Año de producción: 2005.  
Material: patas en policarbonato transparente neutro moldeado por inyección estándar. Tablero en MDF recubierto con lámina polimérica blanca. Disponible también tablero decorado. Porta-lapices en ABS. Disponible también álbum con gráficas para completar y colorear.

Table pour enfants.  
Année de production: 2005.  
Matériaux: pieds en polycarbonate transparent cristall, moulé par injection standard. Plateaux en MDF avec revêtement en polymère blanc. Plateaux décorés sont aussi disponibles. Porte-plumes en ABS. Disponible aussi album avec décorations à compléter et colorier.

Kindertisch.  
Erstproduktion: 2005.  
Material: Tischbeine aus transparentem Polycarbonat, farblos. Hergestellt im Standard-Einspritzverfahren. Tischplatten aus MDF mit weiss polymerer Folie überzogen. Tischplatten auch mit Dekoren erhältlich. Stifftbox aus ABS. Skizzenblock separat erhältlich.

Tavolo per bambini.  
Anno di produzione: 2005.  
Materiali: gambe in policarbonato trasparente neutro stampato ad iniezione standard, piano di MDF rivestito di foglia polimerica bianca. Piano anche con decori. Vaschette portapenne in ABS. Disponibile album con grafiche da completare e colorare.

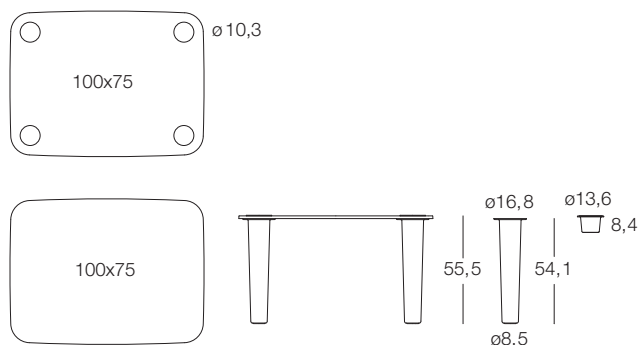

MATT COLOURS  
orange 1001 C (pen holder and feet)  
white 8500 C (top)



## Seggiolina Pop design Enzo Mari • image p-28

Children's chair.  
Year of production: 2004.  
Material: expanded polypropylene.

Silla para niños.  
Año de producción: 2004.  
Material: polipropileno expandido.

Chaise pour enfant.  
Année de production: 2004.  
Matériaux: polypropylène expansé.

Kinderstuhl.  
Erstproduktion: 2004.  
Material: geschäumtes Polypropylen.

Sedia per bambini.  
Anno di produzione: 2004.  
Materiale: polipropilene espanso.

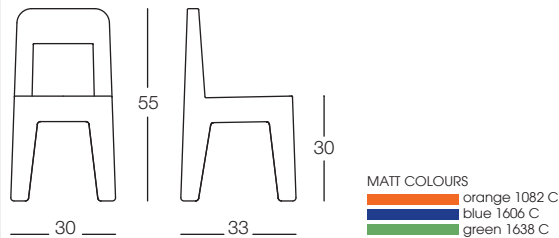

## El Baúl design Javier Mariscal • image p-30

Trunk/container.  
Year of production: 2005.  
Material: rotational-moulded polyethylene.

Baul/contenedor.  
Año de producción: 2005.  
Material: polietileno por moldeo rotacional.

Coffre.  
Année de production: 2005.  
Matériaux: polyéthylène moulé par rotation.

Box.  
Erstproduktion: 2005.  
Material: Polyäthylen. Hergestellt im Rotationsverfahren.

Baule contenitore.  
Anno di produzione: 2005.  
Materiale: polietilene stampato in rotational moulding.

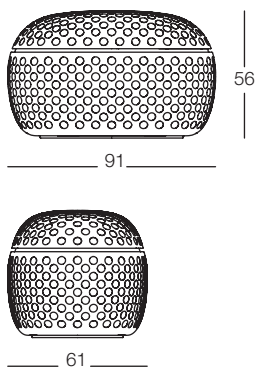

## Puzzle Carpet design Satyendra Pakhalé • image p-30, 50

Puzzle carpet.  
Year of production: 2005.  
Material: soft expanded polyethylene coupled with polyester fabric.

Azulejo/alfombra.  
Año de producción: 2005.  
Material: polietileno expandido morbido cubierto con tela de poliéster.

Tapis/puzzle.  
Année de production: 2005.  
Matériaux: polyéthylène expansé souple avec tissu en polyester.

Puzzle/Teppich.  
Erstproduktion: 2005.  
Material: weiches geschäumtes Polyäthylen mit Polyesterstoff.

Piastrella/tappeto.  
Anno di produzione: 2005.  
Materiale: polietilene espanso morbido accoppiato di tessuto poliestere.

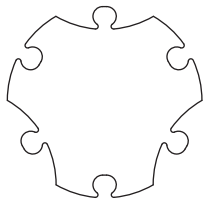

36

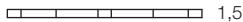

### PATTERNS

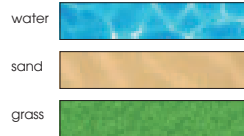

## Reiet design Javier Mariscal • image p-32

Children's chair.  
Year of production: 2011.  
Material: painted solid beech.

Silla para niños.  
Año de producción: 2011.  
Material: madera maciza de haya barnizada.

Chaise pour enfant.  
Année de production: 2011.  
Matériaux: hêtre massif teinté.

Kinderstuhl.  
Erstproduktion: 2011.  
Materialien: massive Buche, gebeizt.

Sedia per bambini.  
Anno di produzione: 2011.  
Materiale: massello di faggio verniciato.

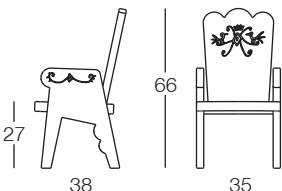

27

66

38

35

### MATT COLOURS





## Alma design Javier Mariscal • image p-34

Stacking children's chair.  
Year of production: 2006.  
Material: polypropylene with glass fibre added. Standard injection-moulded. Suitable for outdoor use.

Silla para niños apilable.  
Año de producción: 2006.  
Material: polipropileno reforzado con fibra de vidrio moldeado por inyección estándar. Apta para el exterior.

Chaise pour enfant empilable.  
Année de production: 2006.  
Matériaux: polypropylène chargé avec fibre de verre moulé par injection standard. Convient pour l'extérieur.

Kinderstuhl, stapelbar.  
Erstproduktion: 2006.  
Material: Polypropylen mit Glasfaser verstärkt. Hergestellt im Standard-Einspritzverfahren. Auch für den Aussenbereich geeignet.

Sedia per bambini impilabile.  
Anno di produzione: 2006.  
Materiale: polipropilene caricato di fibra di vetro stampato ad iniezione standard. Adatta anche per esterni.

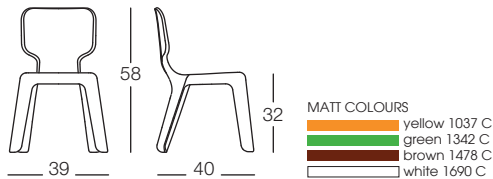

## Linus design Javier Mariscal • image p-34

Children's tables.  
Year of production: 2006.  
Material: legs in polypropylene with glass fibre added. Standard injection-moulded. Top in MDF with polymeric cover.

Mesas para niños.  
Año de producción: 2006.  
Material: patas en polipropileno reforzado con fibra de vidrio moldeado por inyección estándar. Tablero en MDF cubierto con lámina polimérica.

Tables pour enfants.  
Année de production: 2006.  
Matériaux: pieds en polypropylène chargé avec fibre de verre moulé par injection standard. Plateau en MDF avec revêtement en polymère.

Kindertische.  
Erstproduktion: 2006.  
Material: Gestell aus Polypropylen mit Glasfaser verstärkt. Hergestellt im Standard-Einspritzverfahren. Tischplatte aus MDF mit polymerer Folie überzogen.

Tavoli per bambini.  
Anno di produzione: 2006.  
Materiali: gambe in polipropilene caricato di fibra di vetro stampato ad iniezione standard. Piano in MDF rivestito di foglia polimerica.

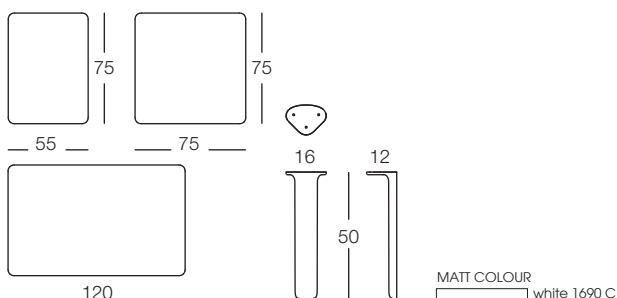

## MICO design El Ultimo Grito • image p-36

A diverse, multi-purpose object.  
Year of production: 2006.  
Material: rotational-moulded polyethylene. Suitable for outdoor use.

Objeto diferente, polivalente.  
Año de producción: 2006.  
Material: polietileno por moldeo rotacional.  
Apto para el exterior.

Objet divers, polyvalent.  
Année de production: 2006.  
Matériaux: polyéthylène moulé par rotation. Conçu pour l'extérieur.

Andersartiges Mehrzweckobjekt.  
Erstproduktion: 2006.  
Material: Polyäthylen. Hergestellt im Rotationsverfahren.  
Auch für den Aussenbereich geeignet.

Oggetto diverso, polivalente.  
Anno di produzione: 2006.  
Materiale: polietilene stampato in rotational moulding.  
Adatto anche per esterni.

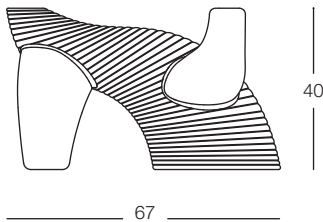
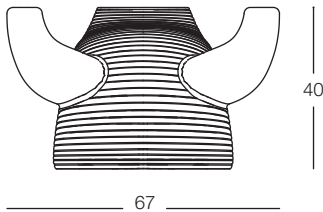

MATT COLOUR  
red 1004 C



## Flying Carpet design Eero Aarnio • image p-38

Flying carpet. Rocking.  
Year of production: 2006.  
Material: base in rotational-moulded polyethylene. Suitable for outdoor use.  
Option extra: carpet in coloured polyamide.

Alfombra voladora.  
Plataforma con movimiento oscilatorio circular.  
Año de producción: 2006.  
Material: plataforma en polietileno por moldeo rotacional. Apta para el exterior.  
Extras: alfombra en poliamida colorada.

Tapis volant. Plateforme à bascule.  
Année de production: 2006.  
Matériaux: plateforme en polyéthylène moulé par rotation. Conçu pour l'extérieur.  
Optionnel: tapis en polyamide coloré.

Fliegender Teppich.  
Schwingende Plattform.  
Erstproduktion: 2006.  
Material: Plattform aus Polyäthylen. Hergestellt im Rotationsverfahren. Auch für den Aussenbereich geeignet.  
Optional: Teppich aus farbigem Polyamid.

Tappeto volante. Piattaforma con movimento oscillatorio circolare.  
Anno di produzione: 2006.  
Materiale: piattaforma in polietilene stampato in rotational moulding. Adatto anche per esterni.  
Optional: tappeto in poliamide colorato.

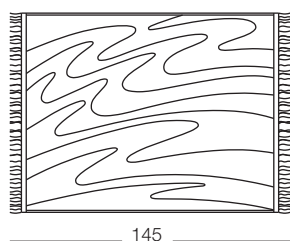
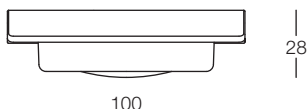
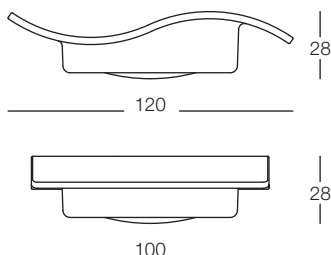

MATT COLOUR  
white 1700 C



# Summer to Spring design El Ultimo Grito • image p-42

Collection of children's clothes. 100% made in Italy. Available in three different sizes (for children ages 2 to 7). Year of production: 2005. Material: cotton.

Colección de ropa para niños. 100% hecha en Italia. Disponible en tre tallas (para niños de 2 a 7 años). Año de producción: 2005. Material: algodón.

Collection de vêtements pour enfants. 100% made in Italy. Disponible en trois tailles différentes (pour enfants de 2 à 7 ans). Année de production: 2005. Matériaux: coton.

Kinderkollektion. 100% made in Italy. In drei verschiedenen Größen erhältlich (für Kinder von 2 bis 7 Jahren). Erstproduktion: 2005. Material: Baumwolle.

Abbigliamento per bambini. 100% made in Italy. Disponibile in tre taglie (per bambini dai 2 ai 7 anni). Anno di produzione: 2005. Materiale: cotone.

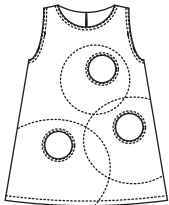

dress

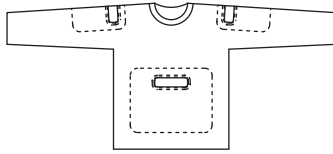

biceps

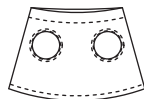

skirt

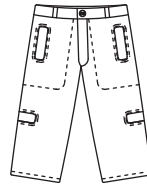

trousers

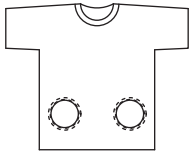

two



abc

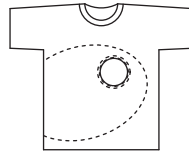

single



colours

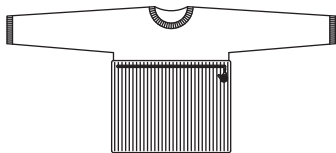

michelin

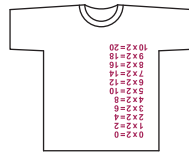

times table

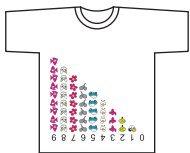

numbers

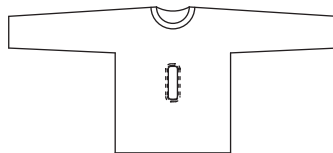

alien

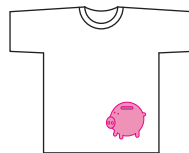

piggy bank



## Bunky design Marc Newson • image p-40

Bed/bunk bed.  
Year of production: 2012.  
Material: rotational-moulded polyethylene.

Cama / litera.  
Año de producción: 2012.  
Material: polietileno por moldeo rotacional.





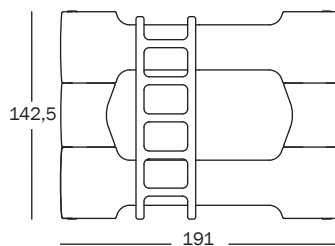
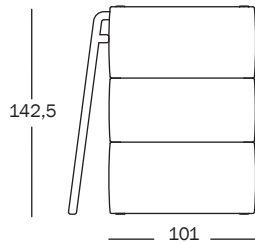

Lit / lit superposé.  
Année de production: 2012.  
Matériaux: polyéthylène moulé par rotation.

Bett - Etagenbett.  
Erstproduktion: 2012.  
Material: Polyäthylen, hergestellt im Rotationsverfahren.

Letto/letto a castello.  
Anno di produzione: 2012.  
Materiale: polietilene stampato in rotational moulding.



### COUPLINGS

	light blue 1218 C (bed)
	blue 1226 C (stacking unit)
	dark blue 1232 C (bed)
	light orange 1652 C (bed)
	orange 1654 C (stacking unit)
	dark orange 1656 C (bed)



## Paradise Tree design Oiva Toikka • image p-44

Coat stand.  
Year of production: 2009.  
Material: elements in rotational-moulded polyethylene. Weight and inner frame in galvanized steel.

Percha de pie.  
Año de producción: 2009.  
Material: polietileno por moldeo rotacional. Lastre y estructura interior en acero cincado en frío.





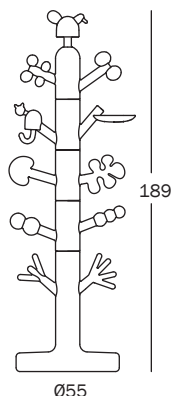
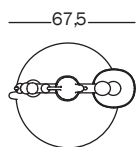

Porte-manteaux.  
Année de production: 2009.  
Matériaux: polyéthylène moulé par rotation. Last et structure intérieure en acier galvanisé.

Kleiderständer.  
Erstproduktion: 2009.  
Material: Polyäthylen. Hergestellt im Rotationsverfahren. Innengewicht und gestell aus verzinktem Stahl.

Appendiabiti.  
Anno di produzione: 2009.  
Materiali: polietilene stampato in rotational moulding. Zavorra e struttura interna in acciaio zincato a freddo.



### MATT COLOURS

	red 1004 C
	white 1735 C
	green 1360 C
	yellow 1665 C
	blue 1220 C
	orange 1001 C

### MATT COLOUR

	white 1735 C
---	--------------

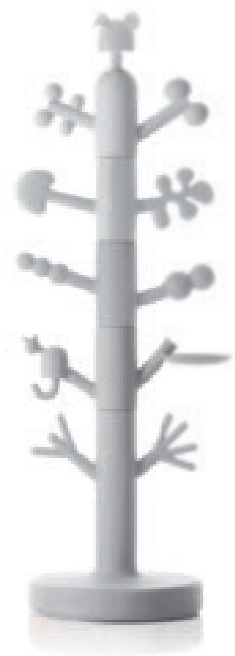
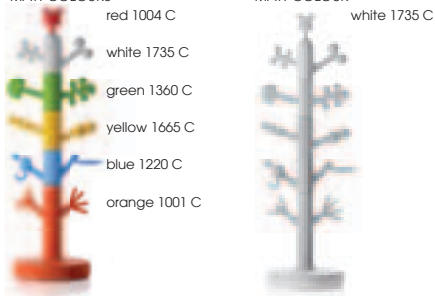

## My Space design Björn Dahlström • image p-46

Space divider.  
Year of production: 2005.  
Material: base in blow-moulded polyethylene. Frame in extruded PVC. Polyester fabric.

Panel divisorio.  
Año de producción: 2005.  
Material: base en polietileno en blow-moulding. Estructura en PVC extruido, tela en poliéster.

Diviseur d'espaces.  
Année de production: 2005.  
Matériaux: base en polyéthylène moulé par soufflage. Structure en PVC extrudé. Tissu en polyester.

Trennwand.  
Erstproduktion: 2005.  
Material: Fuss aus Polyäthylen. Hergestellt im Blow-Moulding Verfahren. Gestell aus extrudiertem PVC. Polyesterstoff.

Pannello divisorio.  
Anno di produzione: 2005.  
Materiali: base in polietilene in blow moulding, stelo in PVC estruso, telo in poliestere.

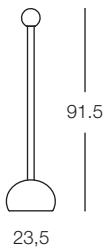
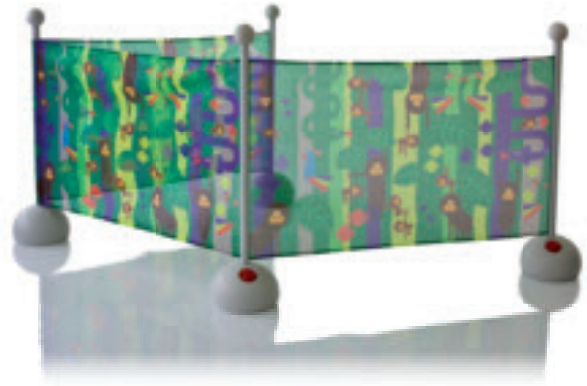
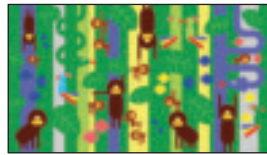
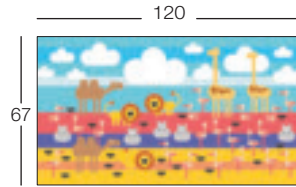
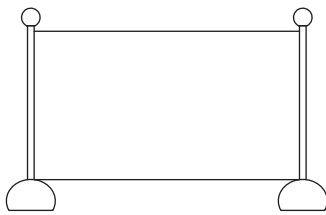

## My House design Björn Dahlström • image p-47

Curtain-cum-tablecloth.  
Year of production: 2005.  
Material: polyester.

Mantel/cortina.  
Año de producción: 2005.  
Material: poliéster.

Rideau/nappe.  
Année de production: 2005.  
Matériaux: polyester.

Vorhang/Tischdecke.  
Erstproduktion: 2005.  
Material: Polyester.

Tovaglia/tenda.  
Anno di produzione: 2005.  
Materiale: poliestere.

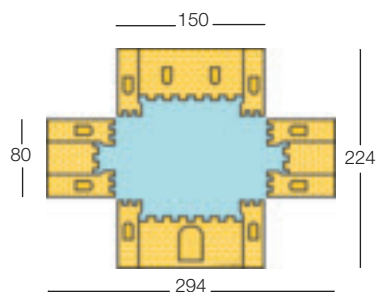

## My Storage design Ineke Hans • image p-48

Shelving and drawer units system.  
Year of production: 2011.  
Materials: uprights in natural solid beech, shelves and drawers in standard-injection moulded ABS. Desk top in HPL laminate.

Sistema modular de estanterías y cómodas.  
Año de producción: 2011.  
Materiales: montantes de madera maciza de haya natural, estantes y cajones en ABS moldeado por inyección estándar. Escritorio en HPL laminado.

Système de rangement à étagères et à tiroirs modulable.  
Année de production: 2011.  
Matériaux: montants en hêtre massif naturel, étagères et tiroirs en ABS moulé par injection standard. Plateau petit bureau en laminé HPL.

Modulares Regal- und Schubkastensystem.  
Erstproduktion: 2011.  
Materialien: Pfeller aus massiver Buche, naturfarben, Ablagen und Schubladen aus ABS, hergestellt im Standard-Einspritzverfahren. Schreibtischplatte aus HPL-Laminat.

Sistema componibile di librerie e cassettiere.  
Anno di produzione: 2011.  
Materiali: montanti in massello di faggio naturale, ripiani e cassette in ABS stampato ad iniezione standard. Piano scrittoio in laminato HPL.

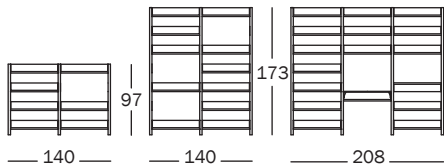
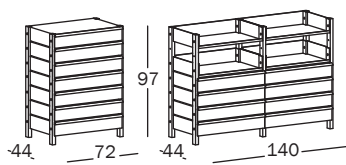

MATT COLOURS  
 natural beech 7011 (uprights)  
 red 1138 C (drawers and screws)  
 white 1673 C (shelves, drawers and screws)  
 white 8500 (desk)



## Tuttifrutti design Stefano Giovannoni • image p-50

Stacking basket.  
Year of production: 2000.  
Material: standard injection-moulded SAN. Can be supplied with wheels.

Contenedor porta-objetos apilable.  
Año de producción: 2000.  
Material: SAN moldeado por inyección estándar. Ruedas también disponibles.

Corbeille porte-objets empilable.  
Année de production: 2000.  
Matériaux: SAN moulé par injection standard. Livrable aussi sur roulettes.

Allzweckkiste, stapelbar.  
Erstproduktion: 2000.  
Material: SAN, hergestellt im Standard-Einspritzverfahren. Zusätzlich auch mit Rollen lieferbar.

Cassetta portaoggetti impilabile.  
Anno di produzione: 2000.  
Materiale: SAN stampato ad iniezione standard. Anche su ruote.

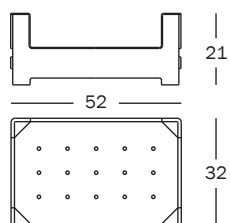

TRANSPARENT COLOURS  
 blue 2530 TR  
 orange 2510 TR



## Ladrillos design Javier Mariscal • image p-52

Shelving system.  
Year of production: 2005.  
Material: shelf supports in rotational-moulded polyethylene. Shelves in HPL laminate white with black edge.

Librería modular.  
Año de producción: 2005.  
Material: ladrillos en polietileno por moldeo rotacional. Estantes en laminado HPL blanco con bordes en negro.

Système d'étagère.  
Année de production: 2005.  
Matériaux: briques en polyéthylène moulé par rotation. Plateaux en laminé HPL blanc avec bord noir.

Regalsystem.  
Erstproduktion: 2005.  
Material: Abstandhalter aus Polyäthylen. Hergestellt im Rotationsverfahren. Ablagen aus HPL-Laminat weiss mit schwarzer Kante.

Libreria componibile.  
Anno di produzione: 2005.  
Materiali: mattoni in polietilene stampato in rotational moulding. Piani di laminato HPL bianco, bordo nero.

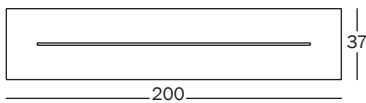
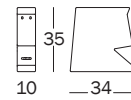
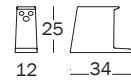
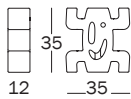
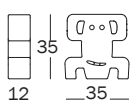
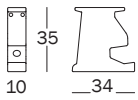
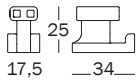
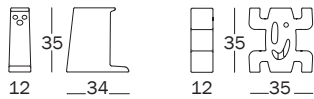

### MATT COLOURS (shelf supports)

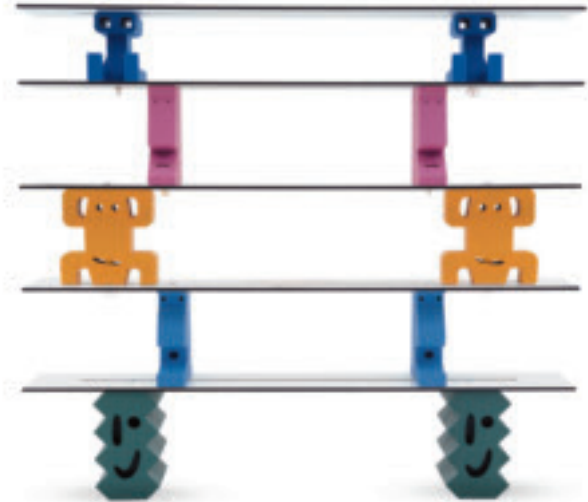

## Downtown design Oiva Toikka • image p-54

Shelving system.  
Year of production: 2011.  
Material: rotational-moulded polyethylene.  
Suitable for outdoor use.

Librería.  
Año de producción: 2011.  
Material: polietileno por moldeo rotacional.  
Apto para el exterior.

Bibliothèque.  
Année de production: 2011.  
Matériaux: polyéthylène moulé par rotation.  
Conçue pour l'extérieur.

Regalsystem.  
Erstproduktion: 2011.  
Material: Polyäthylen. Hergestellt im Rotationsverfahren.  
Auch für den Aussenbereich geeignet.

Libreria.  
Anno di produzione: 2011.  
Materiale: polietilene stampato in rotational moulding.  
Adatta anche per esterni.

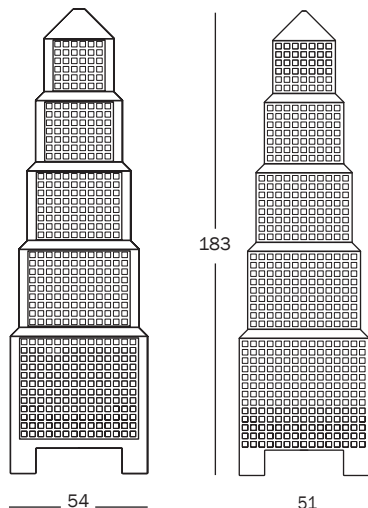

MATT COLOUR  
white 1736 C



## Nido design Javier Mariscal • image p-56

Nest/cave.  
Year of production: 2005.  
Material: rotational-moulded polyethylene. Floor with grass style pattern and graffiti on underside of roof. Suitable for outdoor use.

Guarida.  
Año de producción: 2005.  
Material: polietileno por moldeo rotacional. Suelo con diseño de hierba y techo con graffiti. Apto para el exterior.

Nid/repaire.  
Année de production: 2005.  
Matériaux: polyéthylène moulé par rotation. Sol avec décoration herbe et plafond avec graffiti. Conçu pour l'extérieur.

Höhle.  
Erstproduktion: 2005.  
Material: Polyäthylen. Hergestellt im Rotationsverfahren. Fussboden mit grasähnlichem Dekor, Decke mit Graffiti. Auch für den Aussenbereich geeignet.

Tana.  
Anno di produzione: 2005.  
Materiale: polietilene stampato in rotazionale moulding. Pavimento con disegno erba e soffitto con graffiti. Adatta anche per esterni.

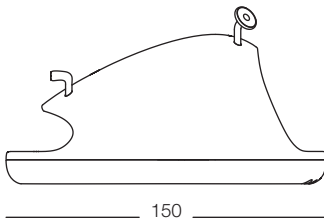
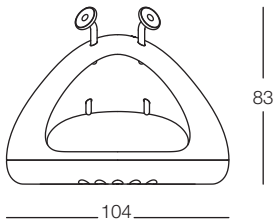

### MATT COLOURS

- yellow (roof) 1025 C
- green (base) 1290 C
- grey anthracite (antennae) 1420 C



## Villa Julia design Javier Mariscal • image p-58

Small house.  
Year of production: 2009.  
Material: cardboard. Complete with stickers for personalization.

Casita.  
Año de producción: 2009.  
Material: cartón. Dotada de pegatinas para la personalización.

Petite maison.  
Année de production: 2009.  
Matériaux: carton. Fourni avec adhésifs pour la personnalisation.

Kleines Haus.  
Erstproduktion: 2009.  
Material: Karton. Komplett mit Aufklebern zur Eigengestaltung.

Casetta.  
Anno di produzione: 2009.  
Materiale: cartone, completa di adesivi per la personalizzazione.

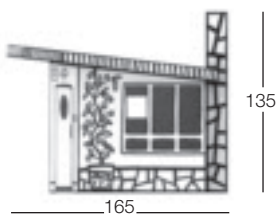

### MATT COLOUR

- white





## My First Office design Martí Guixé • image p-60

Play/learning space.  
Complete with desk adjustable  
in height.  
Year of production: 2012.  
Material: birch plywood.

Espacio de juego-estudio.  
Dotado de mesa con altura  
regulable.  
Año de producción: 2012.  
Material: multistrato de  
abedul.

Espace jeu/étude.  
Fourni avec petit bureau  
régable en hauteur.  
Année de production: 2012.  
Matériaux: bouleau multiplis.

Spiel- oder Arbeitsfläche.  
Komplett mit  
höhenverstellbarem  
Schreibtisch.  
Erstproduktion: 2012.  
Material: Birkenschichtholz.

Spazio-gioco, spazio-studio.  
Completo di scrittoio regolabile  
in altezza.  
Anno di produzione: 2012.  
Materiale: multistrato di betulla.

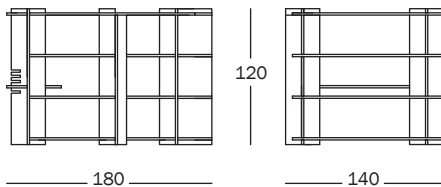

## Football Tape design Martí Guixé • image p-62

Adhesive tape to make paper  
balls.  
Year of production: 2004.  
Material: acrylic polypropylene.  
Non-toxic.

Cinta adhesiva para crear  
balones de papel.  
Año de producción: 2004.  
Material: polipropileno acrílico.  
No tóxico.

Ruban adhésif pour faire des  
ballons en papier.  
Année de production: 2004.  
Matériaux: polypropylène  
acrylique. Non toxique.

Klebeband, um Papierbälle zu  
machen.  
Erstproduktion: 2004.  
Material: Acrylpolypropylen.  
Atoxisch.

Nastro adesivo per creare  
palloni di carta.  
Anno di produzione: 2004.  
Materiale: polipropilene acrilico.  
Atossico.

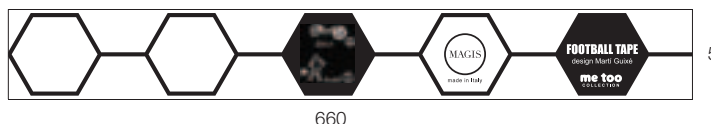
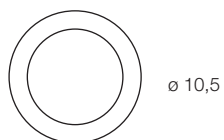

## Moments of Ingenuity signed by Oiva Toikka • image p-14

Five colours (The Elephants) or seven colours (The Camel and the Ostrich) art serigraphy, printed on Fabriano Rosaspina 285gr. paper and mounted on a MDF support.  
Year of production: 2011.

Serigrafía de arte en 5 colores (Los Elefantes) o en 7 colores (El Camello y el Avestruz) impreso en papel Fabriano Rosaspina de 285gr y montado en un soporte de MDF.  
Año de producción: 2011.

Sérigraphie d'art à 5 couleurs (Les Éléphants) ou à 7 couleurs (Le Chameau et l'Australoise) imprimée sur papier Fabriano Rosaspina 285 gr et montée sur support en MDF.  
Année de production: 2011.

Fünffarbige (Die Elefanten) oder siebenfarbige (Das Kamel und der Strauß) Kunstserigraphie, auf Fabriano Rosaspina 285 gr. Papier gedruckt und auf ein MDF Tafel geklebt.  
Erstproduktion: 2011.

Serigrafia d'arte a 5 colori (Gli Elefanti) o 7 colori (Il Cammello e lo Struzzo) stampata su carta Fabriano Rosaspina 285gr e montata su supporto di MDF.  
Anno di produzione: 2011.



70

100



70

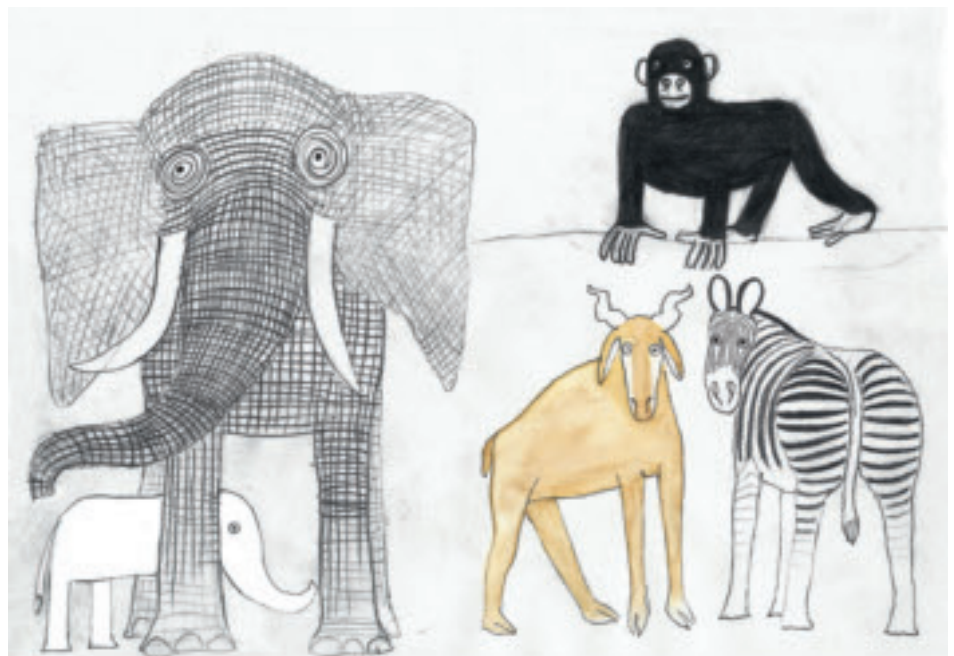

## Designers' index

Eero Aarnio	
Flying Carpet .....	38
Pingy .....	24
Puppy .....	08
Trioli .....	20
Rea Aarnio-Gibson	
Sunny Day .....	14
Björn Dahlström	
My House .....	47
My Space .....	46
Stefano Giovannoni	
Tuttifrutti .....	50
El Ultimo Grito	
Mico .....	36
Summer to Spring .....	42
Marti Guixé	
Football Tape .....	62
My First Office .....	60
My Zoo .....	04
Ineke Hans	
My Storage .....	48
Enzo Mari	
Seggiolina Pop .....	28
Javier Mariscal	
Alma and Linus .....	34
El Baúl .....	30
Julian .....	22
Ladrillos .....	52
Nido .....	56
Piedras .....	26
Reiet .....	32
Villa Julia .....	58
Benedetta Mori Ubaldini	
Birds .....	06
Clouds .....	06
Marc Newson	
Bunky .....	40
Rocky .....	14
Satyendra Pakhalé	
Puzzle Carpet .....	50
Oiva Toikka	
Dodo .....	16
Downtown .....	54
Paradise Tree .....	44
Moments of Ingenuity .....	14
Marcel Wanders	
Little Flare .....	28

## Alphabetical index

Alma .....	34
Birds .....	06
Bunky .....	40
Clouds .....	06
Dodo .....	16
Downtown .....	54
El Baúl .....	30
Flying Carpet .....	38
Football Tape .....	62
Julian .....	22
Ladrillos .....	52
Linus .....	34
Little Flare .....	28
Mico .....	36
Moments of Ingenuity .....	14
My First Office .....	60
My House .....	47
My Space .....	46
My Storage .....	48
My Zoo .....	04
Nido .....	56
Paradise Tree .....	44
Piedras .....	26
Pingy .....	24
Puppy .....	08
Puzzle Carpet .....	50
Reiet .....	32
Rocky .....	14
Seggiolina Pop .....	28
Summer to Spring .....	42
Sunny Day .....	14
Trioli .....	20
Tuttifrutti .....	50
Villa Julia .....	58



### **Magis Spa**

Via Triestina - Accesso E  
Z.I. Ponte Tezze  
30020 Torre di Mosto (VE)  
Italy

T +39 0421 319600  
F +39 0421 319700

info@magisdesign.com  
www.magisdesign.com  
www.magismetoo.com

@Magis 2012

Printing: OGM, Padova

Special thanks to Chicco (p. 58) and Asia (p. 62) for their patience.

Me Too is a registered trademark of Magis Spa. All rights reserved. No part of this publication may be reproduced, stored in a retrieval system or transmitted, in any form or by any means, electronic, mechanical, photocopying, recording or otherwise, without the prior permission of Magis Spa.

Magis reserves the right to introduce any changes to its own models, without prior notice.